

Z 206

Dimensions

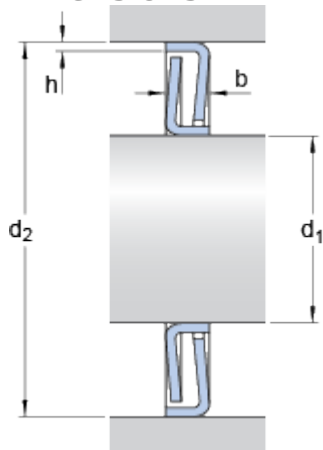

d_1	30	mm
d_2	62	mm
b	6	mm
h	1.5	mm

Mass

Mass	60	g
------	----	---

Appropriate products

- Appropriate spacing washer on the shaft
- Appropriate spacing washer in the housing

[ZW 30x37](#)
[ZW 50x62](#)