

PHE 1080TGRSB

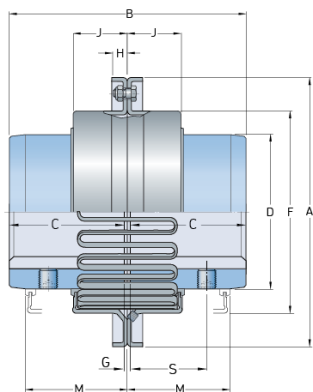

Size	1080
Nominal torque (lbft)	1512
Nominal torque (Nm)	2050
Min. bore (mm)	27
Max speed (r/min)	4750
Min. bore (in)	1.06
Max. bore (mm)	79
Max. bore (in)	3.11
Weight (kg)	7
Weight (lbs)	15.43