

PHE 1060TGHCOVER

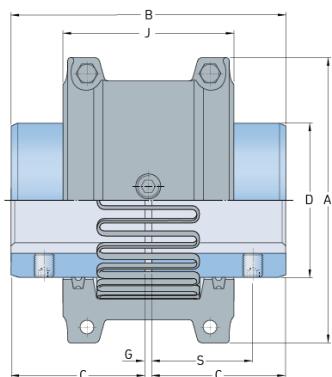

Size	1060
Nominal torque (lbft)	504.49
Nominal torque (Nm)	684
Min. bore (mm)	19
Max speed (r/min)	4350
Min. bore (in)	0.75
Max. bore (mm)	57
Max. bore (in)	2.24
Weight (kg)	1.21
Weight (lbs)	2.67