

# PHC 40-2C/L

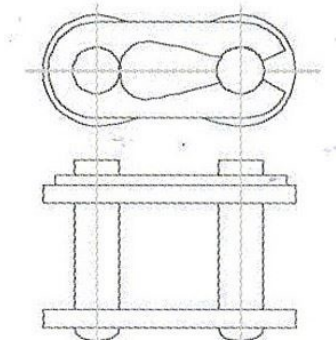

Type of link	C/L
--------------	-----