

PCM 606560 E

Dimensions

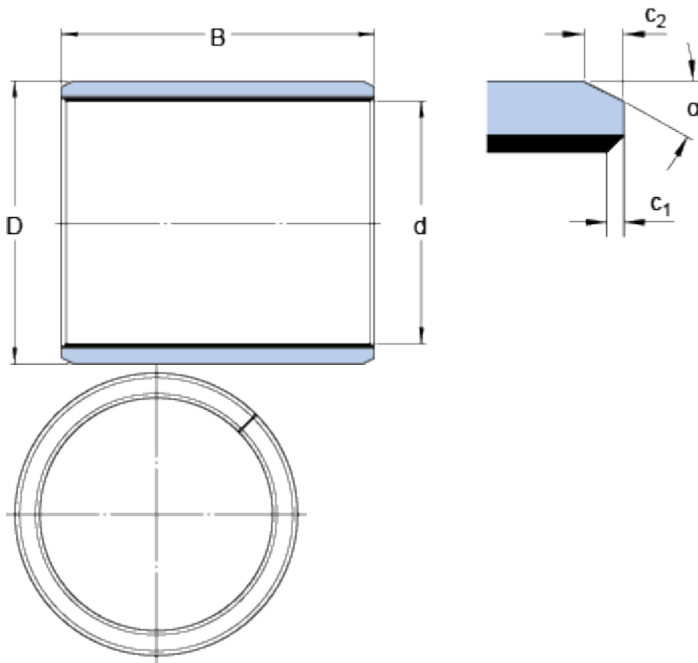

d		60	mm
D		65	mm
B		60	mm
c ₁	min.	0.2	mm
c ₁	max.	1	mm
c ₂	min.	1.2	mm
c ₂	max.	2.4	mm
α	±8	20	°

Recommended fits

Tolerance shaft	f7
Tolerance housing	H7

Calculation data

Basic dynamic load rating - radial direction	C	285	kN
Basic static load rating - radial direction	C	880	kN
Specific dynamic load factor	K	80	N/mm ²
Specific static load factor	K	250	N/mm ²
Factor depending on material and bearing type	K _M	480	
Permissible sliding velocity	v min.	0	m/s
Permissible sliding velocity	v max.	2	m/s
Coefficient of friction	μ min.	0.03	
Coefficient of friction	μ max.	0.25	

Mass

Mass bushing	0.22	kg
--------------	------	----