

# PCM 15015560 E

## Dimensions

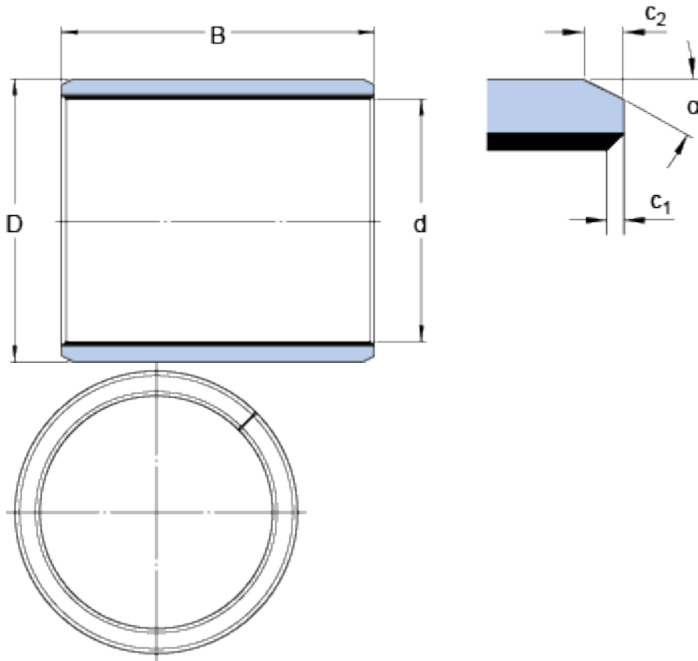

d		150	mm
D		155	mm
B		60	mm
c <sub>1</sub>	min.	0.2	mm
c <sub>1</sub>	max.	1	mm
c <sub>2</sub>	min.	1.2	mm
c <sub>2</sub>	max.	2.4	mm
α	±8	20	°

## Recommended fits

Tolerance shaft	h8
Tolerance housing	H7

## Calculation data

Basic dynamic load rating - radial direction	C	710	kN
Basic static load rating - radial direction	C	2200	kN
Specific dynamic load factor	K	80	N/mm <sup>2</sup>
Specific static load factor	K	250	N/mm <sup>2</sup>
Factor depending on material and bearing type	K <sub>M</sub>	480	
Permissible sliding velocity	v	min. 0	m/s
Permissible sliding velocity	v	max. 2	m/s
Coefficient of friction	μ	min. 0.03	
Coefficient of friction	μ	max. 0.25	

## Mass

Mass bushing	0.54	kg
--------------	------	----