

PBM 506050 M1G1

Dimensions

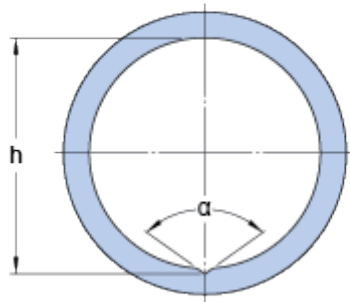
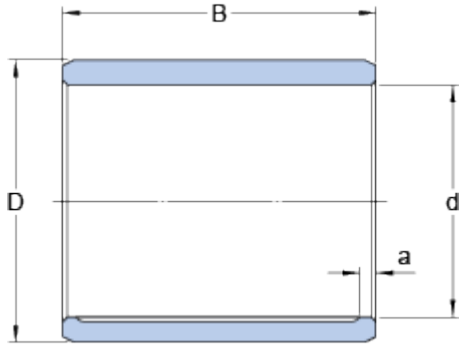

d	50	mm
D	60	mm
B	50	mm
a	3	mm
h	51	mm
α	124	°

Recommended fits

Tolerance shaft	e7
Tolerance housing	H7

Calculation data

Specific dynamic load factor	K	25	N/mm ²
Specific static load factor	K	45	N/mm ²
Permissible sliding velocity	v	min.	0 m/s
Permissible sliding velocity	v	max.	0.5 m/s
Coefficient of friction	μ	min.	0.08
Coefficient of friction	μ	max.	0.15

Mass

Mass bushing	0.38	kg
--------------	------	----