

HK 2816

Dimensions

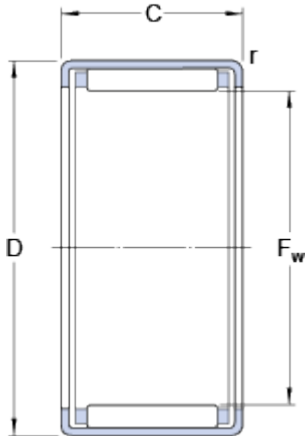

F_w	28	mm
D	35	mm
C	16	mm
r	min. 0.8	mm

Calculation data

Basic dynamic load rating	C	15.7	kN
Basic static load rating	C	26.5	kN
Fatigue load limit	P_u	3.15	kN
Reference speed		9000	r/min
Limiting speed		9500	r/min

Mass

Mass bearing		0.027	kg
Designation		HK 2816	

Associated products

Inner ring IR series		IR 22x28x17
Radial shaft seal with a low cross-sectional height, single lip		G 28x35x4
Radial shaft seal with a low cross-sectional height, double lip		SD 28x35x4