

HK 2212

Dimensions

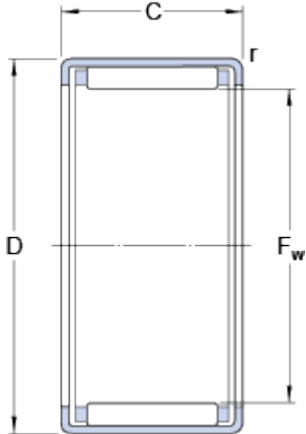

F_w	22	mm
D	28	mm
C	12	mm
r	min. 0.8	mm

Calculation data

Basic dynamic load rating	C	8.8	kN
Basic static load rating	C	13.7	kN
Fatigue load limit	P_u	1.56	kN
Reference speed		11000	r/min
Limiting speed		12000	r/min

Mass

Mass bearing		0.015	kg
Designation		HK 2212	

Associated products

Inner ring IR series		IR 17x22x13
Radial shaft seal with a low cross-sectional height, single lip		G 22x28x4
Radial shaft seal with a low cross-sectional height, double lip		SD 22x28x4