

HK 2016

Dimensions

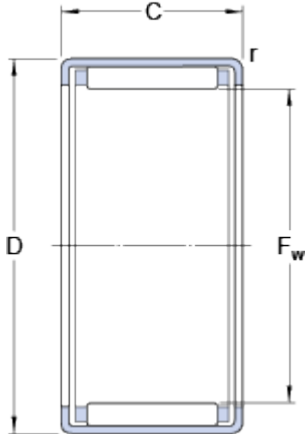

F _w	20	mm
D	26	mm
C	16	mm
r	min. 0.8	mm

Calculation data

Basic dynamic load rating	C	12.3	kN
Basic static load rating	C	20.4	kN
Fatigue load limit	P _u	2.36	kN
Reference speed		12000	r/min
Limiting speed		14000	r/min

Mass

Mass bearing		0.019	kg
Designation		HK 2016	

Associated products

Inner ring IR series	IR 17x20x16.5
Inner ring LR series	LR 17x20x16.5
Radial shaft seal with a low cross-sectional height, single lip	G 20x26x4
Radial shaft seal with a low cross-sectional height, double lip	SD 20x26x4