

HK 1712

Dimensions

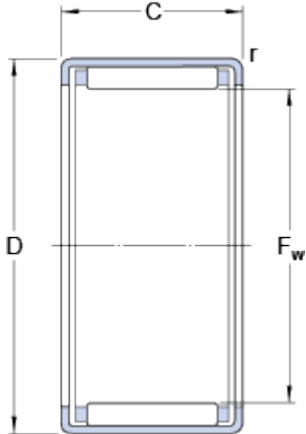

F_w	17	mm
D	23	mm
C	12	mm
r	min. 0.8	mm

Calculation data

Basic dynamic load rating	C	7.65	kN
Basic static load rating	C	10.6	kN
Fatigue load limit	P_u	1.2	kN
Reference speed		14000	r/min
Limiting speed		15000	r/min

Mass

Mass bearing		0.013	kg
Designation		HK 1712	

Associated products

Radial shaft seal with a low cross-sectional height, single lip	G 17x23x3
Radial shaft seal with a low cross-sectional height, double lip	SD 17x23x3