

# HK 1616

## Dimensions

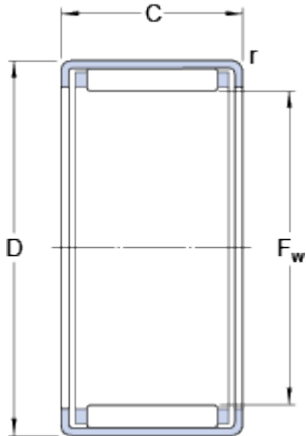

$F_w$	16	mm
D	22	mm
C	16	mm
r	min. 0.8	mm

## Calculation data

Basic dynamic load rating	C	10.5	kN
Basic static load rating	C	15.6	kN
Fatigue load limit	$P_u$	1.8	kN
Reference speed		14000	r/min
Limiting speed		16000	r/min

## Mass

Mass bearing		0.016	kg
Designation		HK 1616	

## Associated products

Inner ring IR series		IR 12x16x16
Radial shaft seal with a low cross-sectional height, single lip		<a href="#">G 16x22x3</a>
Radial shaft seal with a low cross-sectional height, double lip		<a href="#">SD 16x22x3</a>