

HK 1512

Dimensions

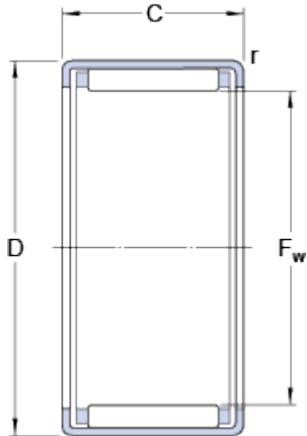

F_w	15	mm
D	21	mm
C	12	mm
r	min. 0.8	mm

Calculation data

Basic dynamic load rating	C	7.65	kN
Basic static load rating	C	9.5	kN
Fatigue load limit	P_u	1.08	kN
Reference speed		15000	r/min
Limiting speed		16000	r/min

Mass

Mass bearing		0.011	kg
Designation		HK 1512	

Associated products

Inner ring IR series	IR 12x15x12.5
Inner ring LR series	LR 12x15x12.5
Radial shaft seal with a low cross-sectional height, single lip	G 15x21x3
Radial shaft seal with a low cross-sectional height, double lip	SD 15x21x3