

# HK 1212

## Dimensions

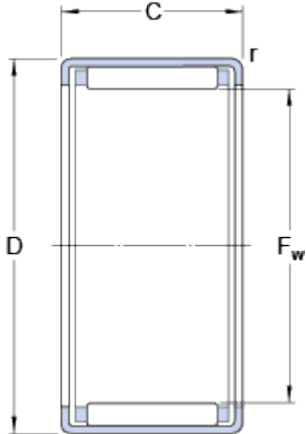

$F_w$	12	mm
D	18	mm
C	12	mm
r	min. 0.8	mm

## Calculation data

Basic dynamic load rating	C	6.27	kN
Basic static load rating	C	7.35	kN
Fatigue load limit	$P_u$	0.85	kN
Reference speed		16000	r/min
Limiting speed		18000	r/min

## Mass

Mass bearing	0.0095	kg
Designation	HK 1212	

## Associated products

Inner ring IR series	IR 8x12x12.5
Inner ring LR series	<a href="#">LR 8x12x12.5</a>
Radial shaft seal with a low cross-sectional height, single lip	<a href="#">G 12x18x3</a>
Radial shaft seal with a low cross-sectional height, double lip	<a href="#">SD 12x18x3</a>