

HK 1210

Dimensions

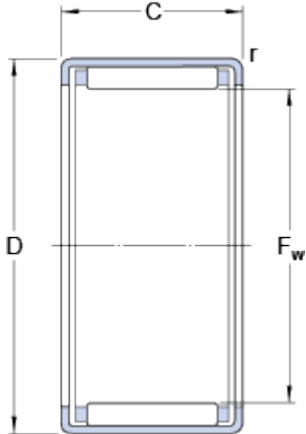

F _w	12	mm
D	16	mm
C	10	mm
r	min. 0.4	mm

Calculation data

Basic dynamic load rating	C	4.84	kN
Basic static load rating	C	6.4	kN
Fatigue load limit	P _u	0.71	kN
Reference speed		16000	r/min
Limiting speed		18000	r/min

Mass

Mass bearing	0.0046	kg
Designation	HK 1210	

Associated products

Inner ring IR series	IR 8x12x10.5
Inner ring LR series	LR 8x12x10.5
Radial shaft seal with a low cross-sectional height, single lip	G 12x16x3