

HK 1014.2RS

Dimensions

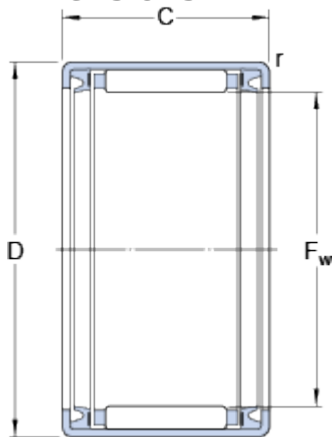

F _w	10	mm
D	14	mm
C	14	mm
r	min. 0.4	mm

Calculation data

Basic dynamic load rating	C	4.29	kN
Basic static load rating	C	5.3	kN
Fatigue load limit	P _u	0.57	kN
Limiting speed		12000	r/min

Mass

Mass bearing		0.0046	kg
Designation		HK 1014.2RS	