

# HK 0912

## Dimensions

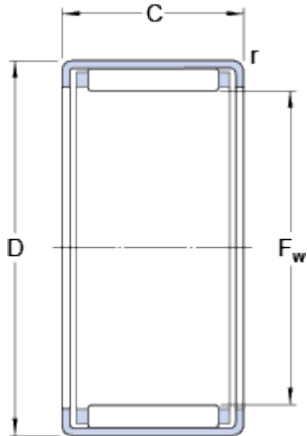

F <sub>w</sub>	9	mm
D	13	mm
C	12	mm
r	min. 0.4	mm

## Calculation data

Basic dynamic load rating	C	5.12	kN
Basic static load rating	C	6.4	kN
Fatigue load limit	P <sub>u</sub>	0.72	kN
Reference speed		18000	r/min
Limiting speed		20000	r/min

## Mass

Mass bearing	0.0046	kg
Designation	HK 0912	

## Associated products

Inner ring IR series	IR 6x9x12
Radial shaft seal with a low cross-sectional height, single lip	<a href="#">G 9x13x3</a>