

HK 0908

Dimensions

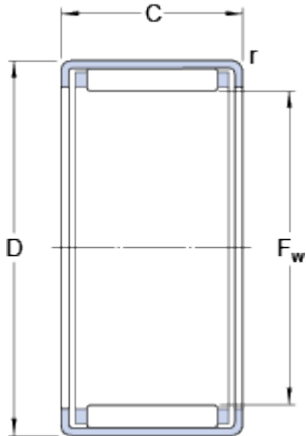

F _w	9	mm
D	13	mm
C	8	mm
r	min. 0.4	mm

Calculation data

Basic dynamic load rating	C	3.52	kN
Basic static load rating	C	3.9	kN
Fatigue load limit	P _u	0.415	kN
Reference speed		18000	r/min
Limiting speed		20000	r/min

Mass

Mass bearing		0.003	kg
Designation		HK 0908	

Associated products

Radial shaft seal with a low cross-sectional height, single lip

[G 9x13x3](#)