

# HK 0609

## Dimensions

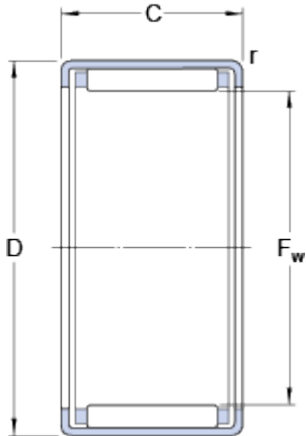

$F_w$	6	mm
D	10	mm
C	9	mm
r	min. 0.4	mm

## Calculation data

Basic dynamic load rating	C	2.81	kN
Basic static load rating	C	2.7	kN
Fatigue load limit	$P_u$	0.285	kN
Reference speed		20000	r/min
Limiting speed		22000	r/min

## Mass

Mass bearing		0.0025	kg
Designation		HK 0609	

## Associated products

Radial shaft seal with a low cross-sectional height, single lip

[G 6x10x2 S](#)