

# HK 0509

## Dimensions

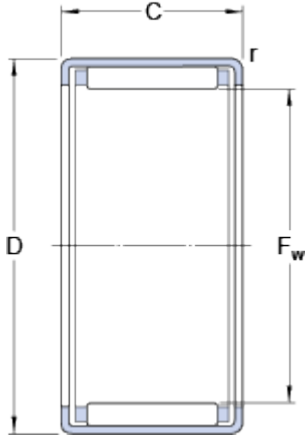

$F_w$	5	mm
D	9	mm
C	9	mm
r	min. 0.4	mm

## Calculation data

Basic dynamic load rating	C	2.38	kN
Basic static load rating	C	2.08	kN
Fatigue load limit	$P_u$	0.22	kN
Reference speed		22000	r/min
Limiting speed		24000	r/min

## Mass

Mass bearing		0.002	kg
Designation		HK 0509	

## Associated products

Radial shaft seal with a low cross-sectional height, single lip

[G 5x9x2 S](#)