

FYK 505

Dimensions

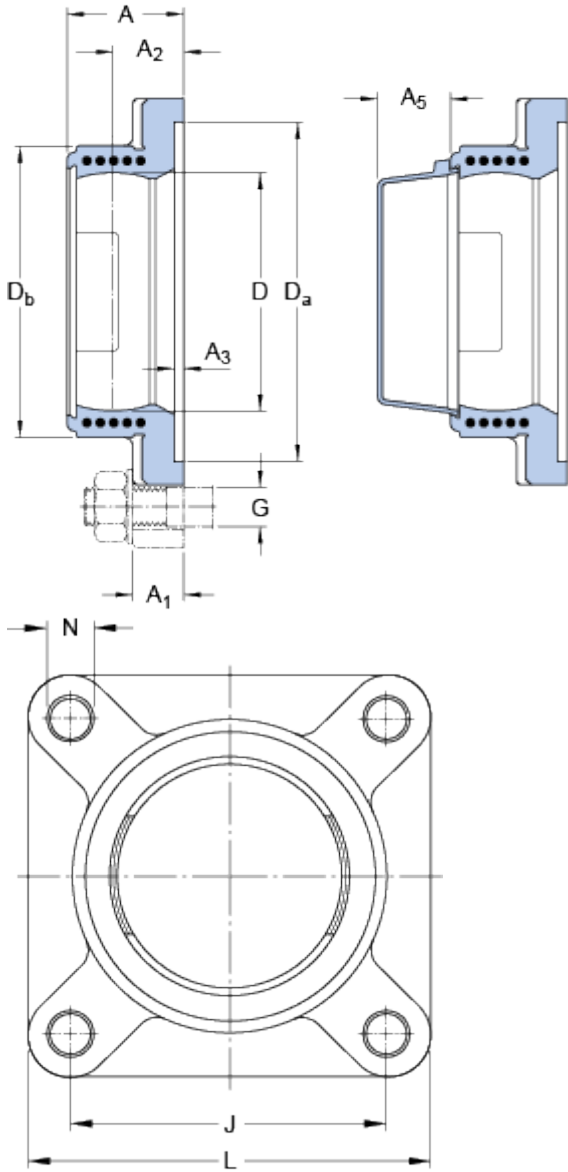

D		52	mm
D _a	H11	74.6	mm
D _b		65	mm
A		31	mm
A ₁		15	mm
A ₂		19	mm
A ₃	H14	3.2	mm
A ₅		18	mm
J		70	mm
L		95	mm
N		12.3	mm

Mass

Mass housing	0.14	kg
--------------	------	----

Mounting information

Recommended diameter for attachment bolts, mm	G	10	mm
Recommended diameter for attachment bolts, inch	G	0.375	in

Appropriate products

End cover	ECY 205
-----------	-------------------------