

FYK 504

Dimensions

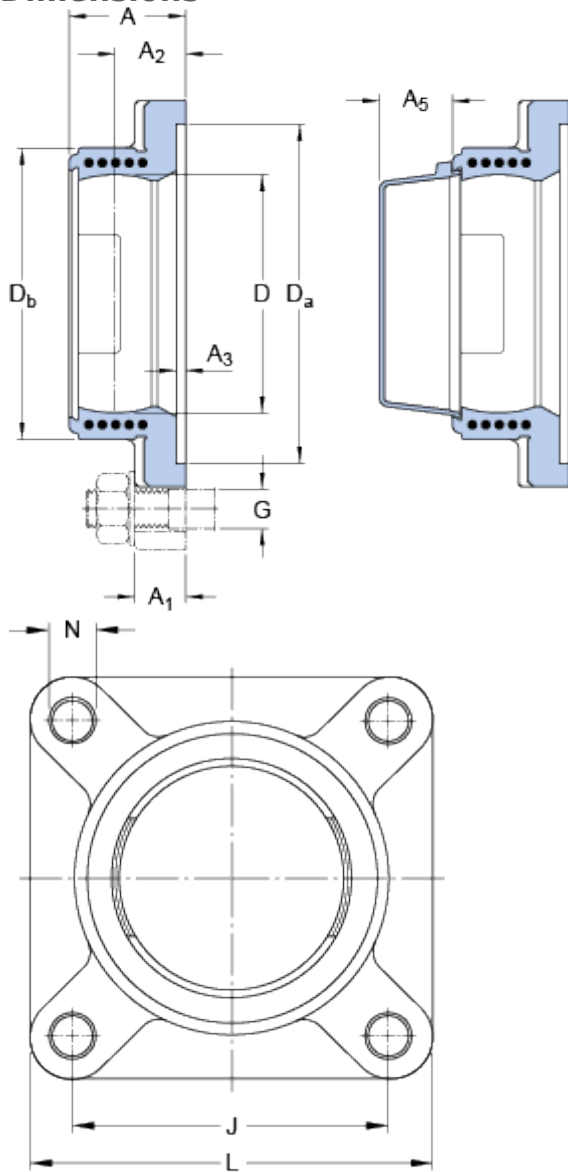

D		47	mm
D _a	H11	68.3	mm
D _b		59	mm
A		30	mm
A ₁		15	mm
A ₂		19	mm
A ₃	H14	3.2	mm
A ₅		18.5	mm
J		63.5	mm
L		86	mm
N		12.3	mm

Mass

Mass housing	0.12	kg
--------------	------	----

Mounting information

Recommended diameter for attachment bolts, mm	G	10	mm
Recommended diameter for attachment bolts, inch	G	0.375	in

Appropriate products

End cover	ECY 204
-----------	-------------------------