

# ECY 210

## Dimensions

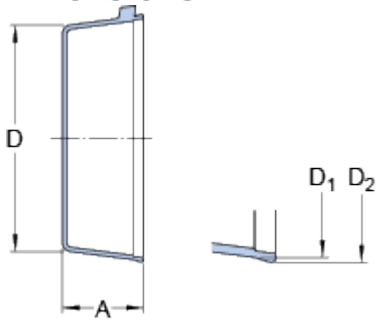

A	35.5	mm
D	85.8	mm
D <sub>1</sub>	94	mm
D <sub>2</sub>	95.5	mm

## Mass

Mass end cover

0.03

kg