

# ECY 204

## Dimensions

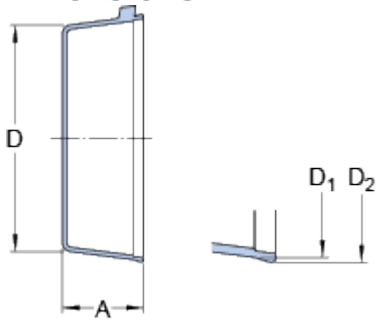

A	23	mm
D	44.1	mm
D <sub>1</sub>	49	mm
D <sub>2</sub>	50.5	mm

## Mass

Mass end cover

0.01

kg