

# SKF TMMK 20-50

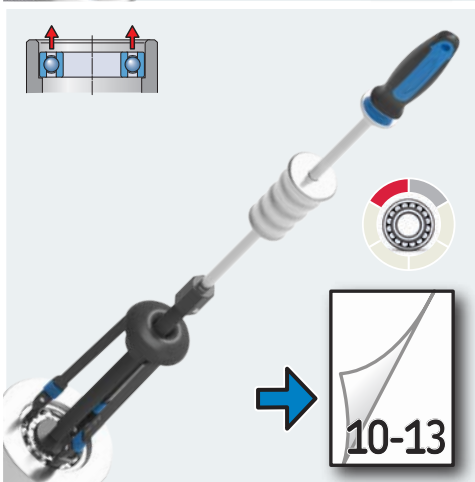

Instructions for use  
Mode d'emploi  
Bedienungsanleitung  
Instrucciones de uso

Manuale d'istruzioni  
Instruções de uso  
使用说明书  
Инструкция по эксплуатации

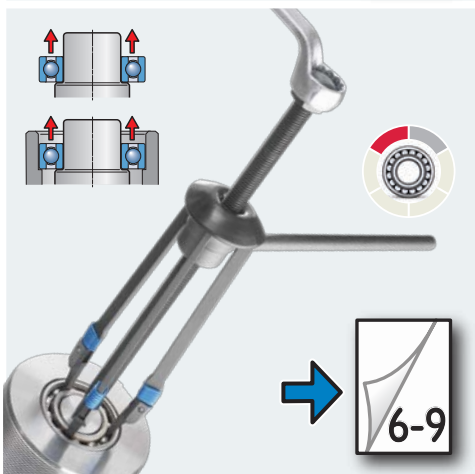
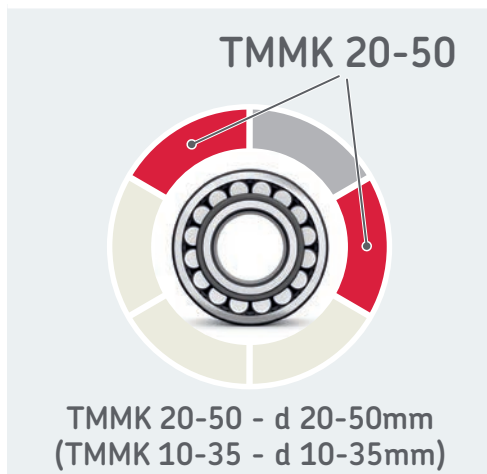
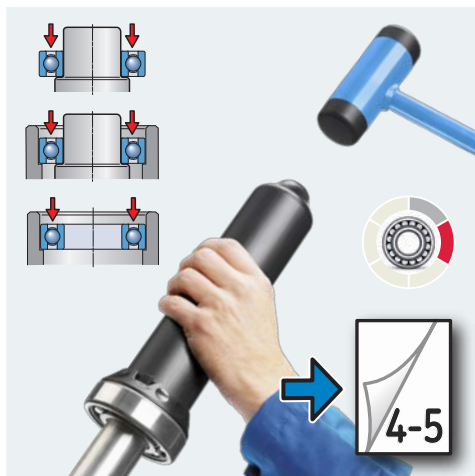
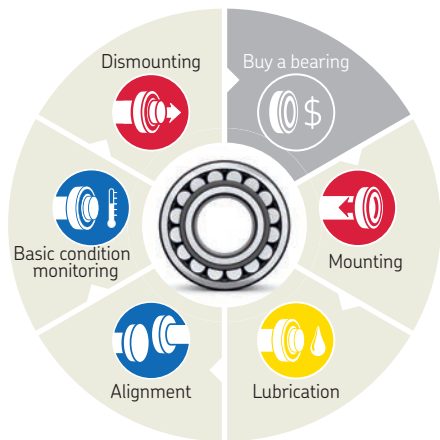

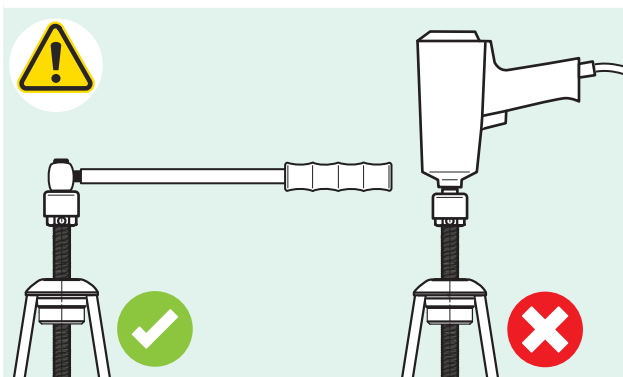
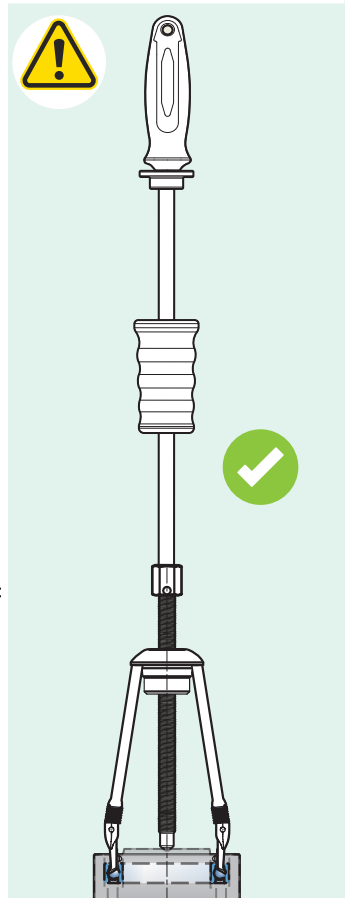
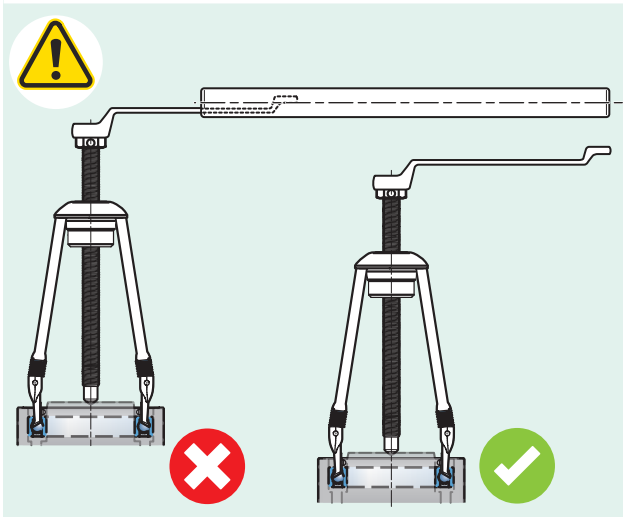
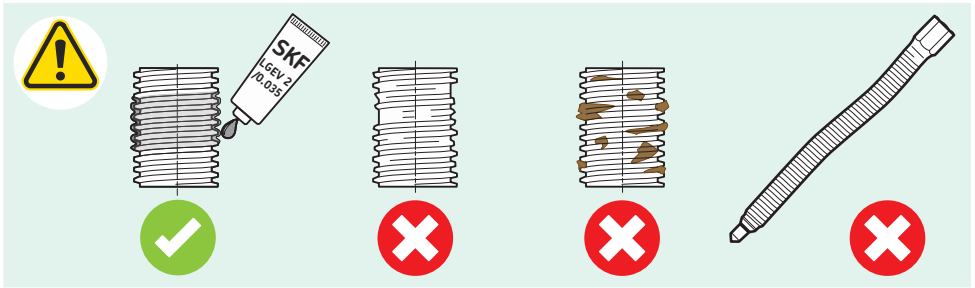
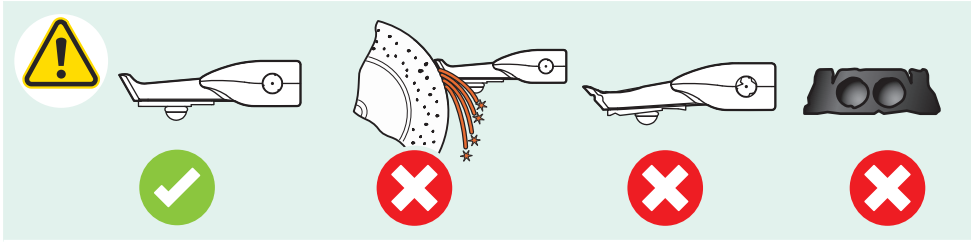

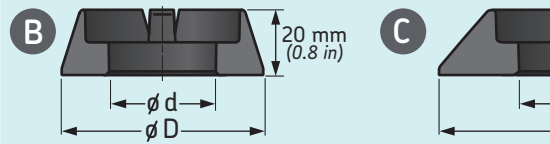
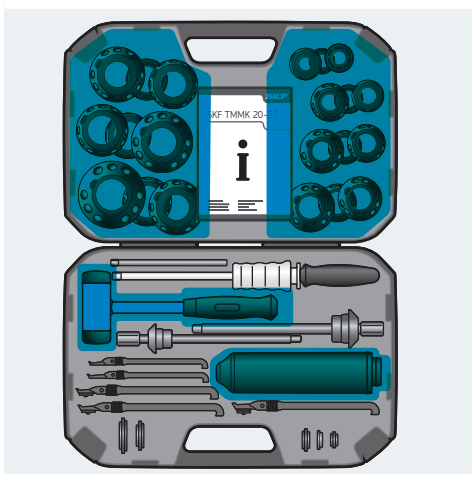
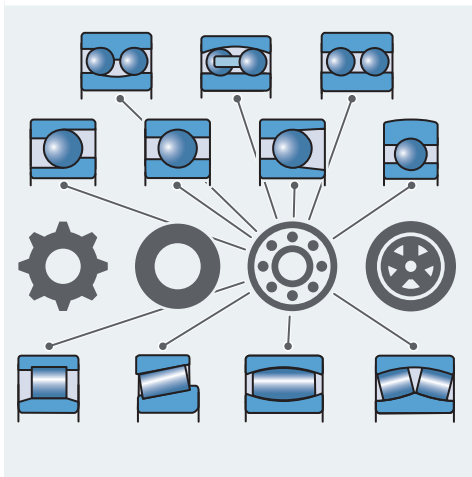
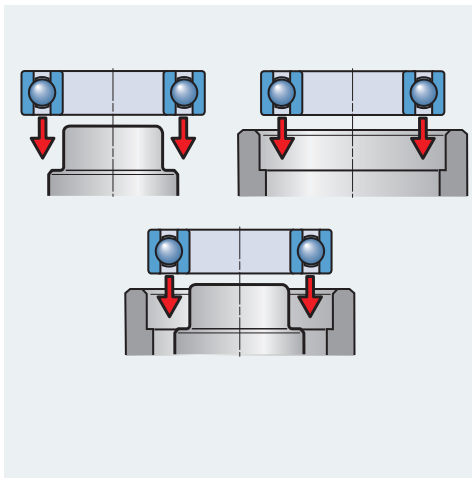

B	d		D	60..	6
	mm	in	mm in		
TMFT 36 B20-42	20	0.8	42 1.6	6004	
TMFT 36 B20-47	20	0.8	47 1.8		6
TMFT 36 B20-52	20	0.8	52 2.0		
TMFT 36 B25-47	25	1.0	47 1.9	6005	6
TMFT 36 B25-52	25	1.0	52 2.0		6
TMFT 36 B25-62	25	1.0	62 2.4		
TMFT 36 B30-55	30	1.2	55 2.2	6006	6
TMFT 36 B30-62	30	1.2	62 2.4		6
TMFT 36 B30-72	30	1.2	72 2.8		
TMFT 36 B35-62	35	1.4	62 2.4	6007	
TMFT 36 B35-72	35	1.4	72 2.8		6
TMFT 36 B35-80	35	1.4	80 3.1		

C	d		D	60..	6
	mm	in	mm in		
TMFT 36 C40-68	40	1.6	68 2.7	6008	
TMFT 36 C40-80	40	1.6	80 3.1		6
TMFT 36 C40-90	40	1.6	90 3.5		
TMFT 36 C45-75	45	1.8	75 2.9	6009	
TMFT 36 C45-85	45	1.8	85 3.3		6
TMFT 36 C45-100	45	1.8	100 3.9		
TMFT 36 C50-80	50	2.0	80 3.1	6010	
TMFT 36 C50-90	50	2.0	90 3.5		6
TMFT 36 C50-110	50	2.0	110 4.3		

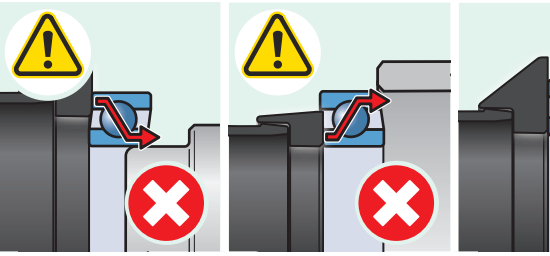

2.. 63.. 64.. 160..
16004
204
6304
2/22 16005
205 63/22
6305 6403
2/28 16006
206 63/28
6306 6404
16007
207
6307 6405
2.. 63.. 64.. 160..
16008
208
6308 6406
16009
209
6309 6407
16010
210
6310 6408

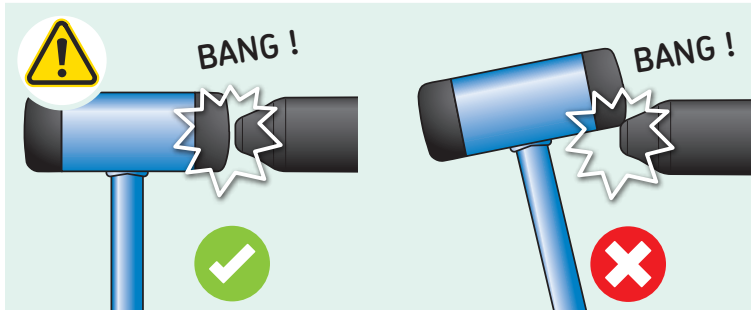

1 ? ? ?

d	D	60	62	64	160
mm in	mm in	mm in	mm in	mm in	mm in
TMFT 36 A10-26	10 0.4	26 1.0	6000		16100
TMFT 36 A10-30	10 0.4	30 1.2	6200		16100
TMFT 36 A10-35	10 0.4	35 1.4		6201	
TMFT 36 A12-28	12 0.5	28 1.1	6001		16101
TMFT 36 A12-32	12 0.5	32 1.3		6201	
TMFT 36 A12-37	12 0.5	37 1.5			16101
TMFT 36 A15-30	15 0.6	32 1.3	6002		
TMFT 36 A15-35	15 0.6	35 1.4	6202		
TMFT 36 A15-42	15 0.6	42 1.7			16101
TMFT 36 A17-35	17 0.7	35 1.4	6003		
TMFT 36 A17-40	17 0.7	40 1.6	6203		
TMFT 36 A17-45	17 0.7	45 1.8		6203	

? ? ?

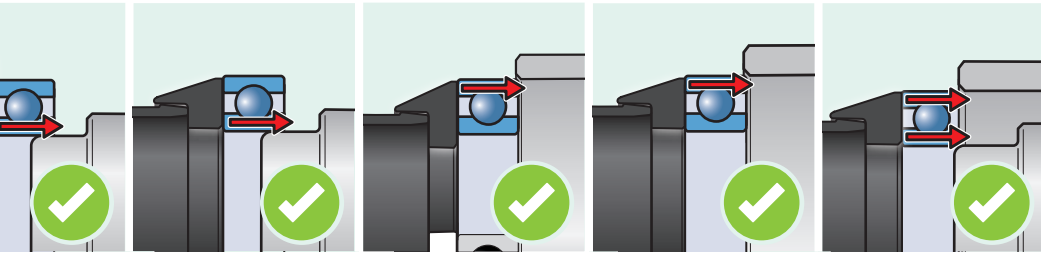
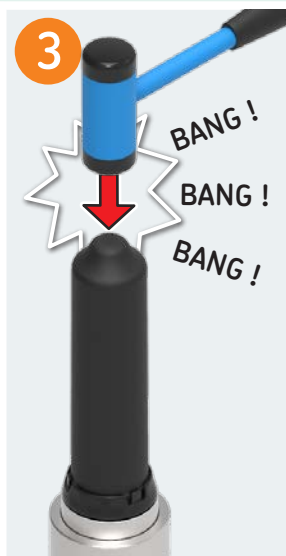

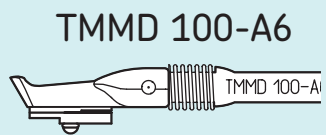
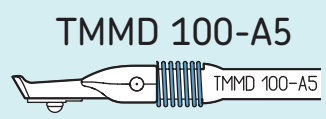
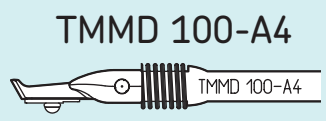
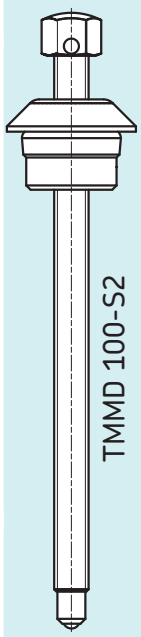
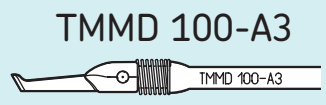
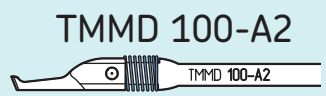
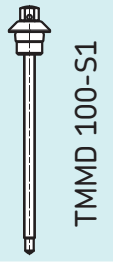
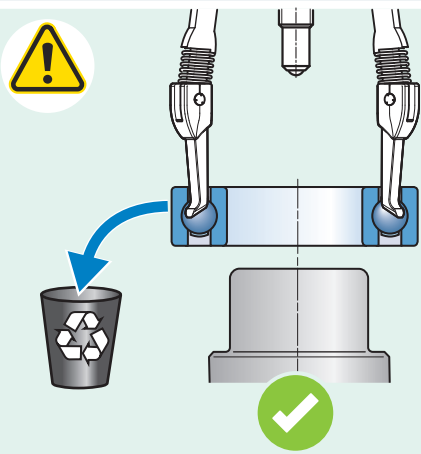
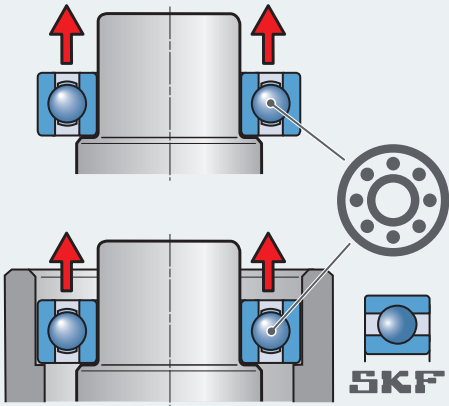



60..	62..	63..	64..	160..
------	------	------	------	-------

6004	6201			
6005	6202			
6006	6203			
6007	6204	6300		16011
6008	6205	6301		
6009	62/22	6302		
6010				



6206	6303
62/28	6304

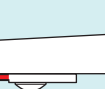

6011	63/22
6012	
6013	



6207	6305
6208	63/28



6014	6209	6306	6403
6015			

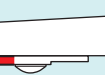

6016	6210	6307
6017	6211	

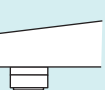

6018		6308	6404
6019			6405
6020			



6212	6406
6213	

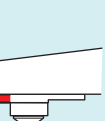

6214	6309	6407
6215	6310	
6216		
6217		

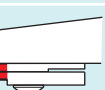

6218	6311	6408
	6312	6409



6313	6410
------	------

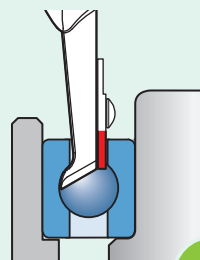
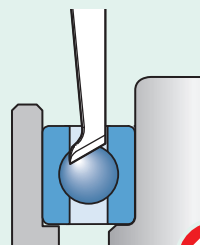
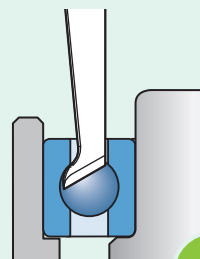
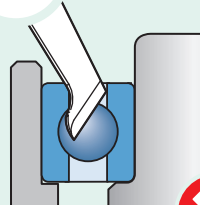

**1** ? ? ?

	60.	62.	63.	64.	160.	161.
	6000	6200			16000	16100
	16003	16101				
TMMD 100-A1	6001	6200				
	6002					
	6003					
TMMD 100-A2	6004	6301				
	6005	6302				
	6006	6303				
TMMD 100-A3	6007	6304	6300			16011
	6008	6305	6301			
	6009	6302	6302			
	6010					
TMMD 100-A4		6306	6303			
		6028	6304			
	6011					
	6012					
	6013					
TMMD 100-A5		6307	6305			
		6308	6306			
		6309	6307			
	6014	6210	6307			
	6015	6211				
	6016					
	6017	6211				
	6018		6308	6404		
	6019					
	6020					
TMMD 100-A6		6212	6306			
		6213	6307			
		6214	6308			
		6215	6309			
		6216				
		6217				
		6218				
		6219				
		6220				

6-7

**2** A4 / A5 / A6

x3

6-7

**3** I

**5** II

~120°

**6** II

**7** III

**9**

**10**

**11**



4

I

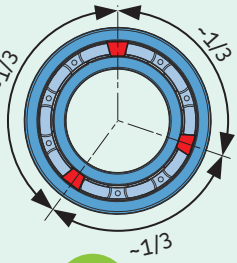
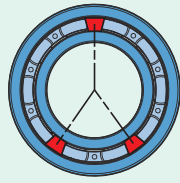
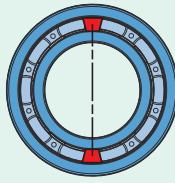
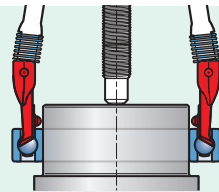

8



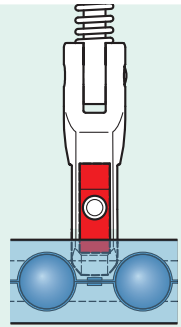
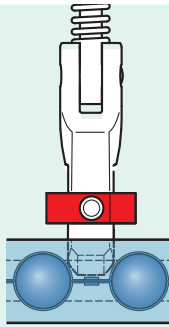
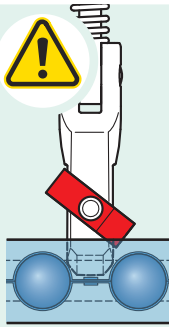



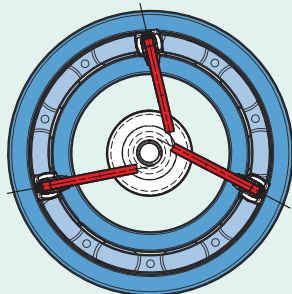
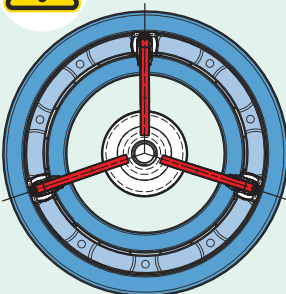

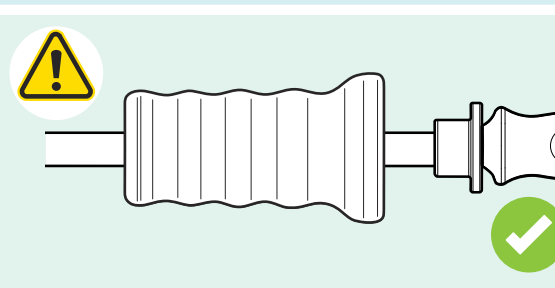
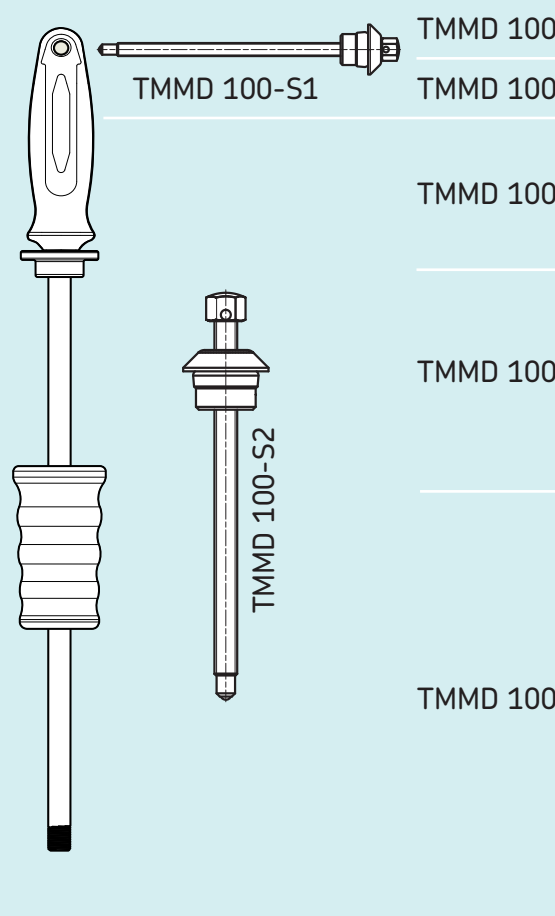
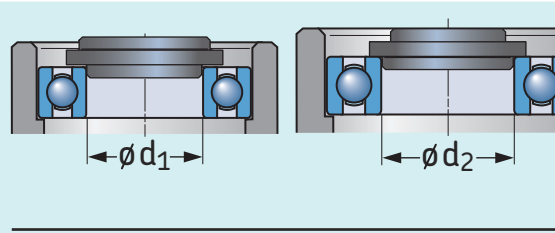
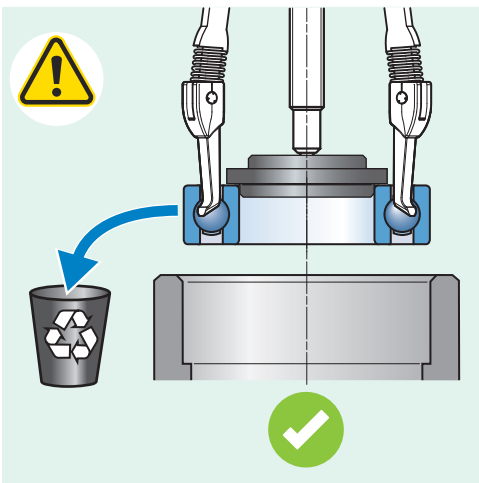
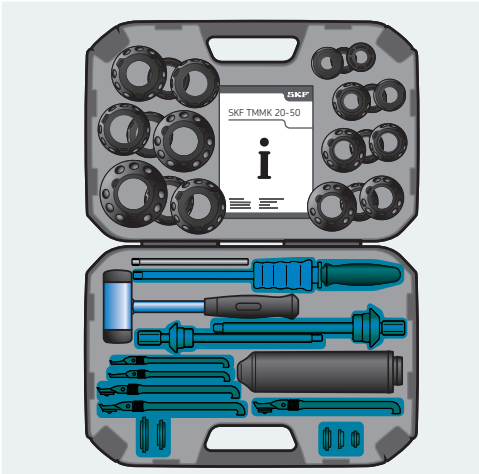
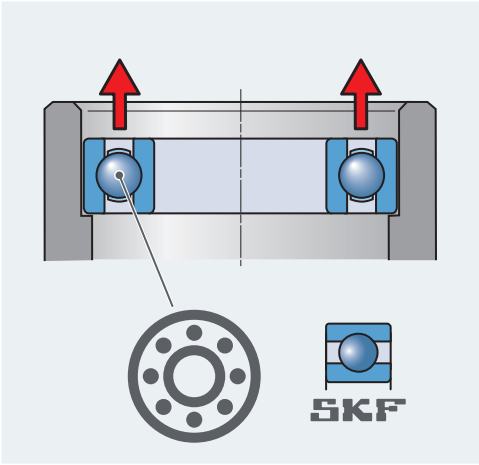







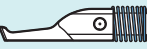

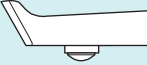
III



12





												
		d <sub>1</sub>	d <sub>2</sub>	d <sub>1</sub>	d <sub>1</sub>	d <sub>2</sub>	d <sub>1</sub>	d <sub>2</sub>	d <sub>1</sub>	d <sub>2</sub>		
	mm	20	22	25	28	30	35	40	45	50		
	in	0.8	0.9	1.0	1.1	1.2	1.4	1.6	1.8	2.0		
-A2		6004		6005		6006						
-A3		6204	62/22	6205				6007	6008	6009	6010	
-A4		6304				62/28	6206					
		63/22										
-A5				6305	63/28		6207		6208			
						6306				6209		
								6307		6210		
		6404		6405				6308				
-A6						6406						
								6407		6309		6310
								6408		6409		
										6410		

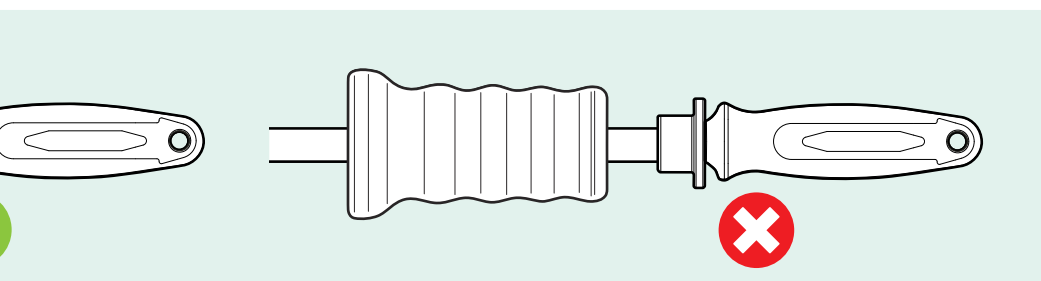

1

? ? ?

	d <sub>1</sub>	d <sub>2</sub>	d <sub>1</sub>	d <sub>2</sub>	d <sub>1</sub>	d <sub>2</sub>	d <sub>1</sub>	d <sub>2</sub>
mm	20	22	25	30	35	40	45	50
in	0.8	0.9	1.0	1.2	1.4	1.6	1.8	2.0
TMMD 100-A2	6004	6005	6006	6007	6008	6009	6010	
TMMD 100-A3	6204	6222	6205					
TMMD 100-A4	6304	6322	6306					
TMMD 100-A5	6305	6328	6306	6207	6208			
TMMD 100-A6	6404	6405	6307	6210				

2

A4/A5/A6

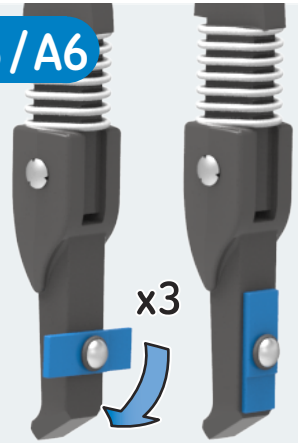
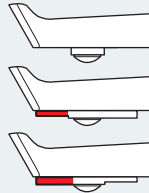

6



7



8

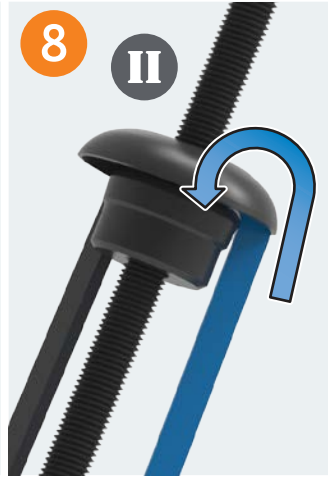

9



10



11



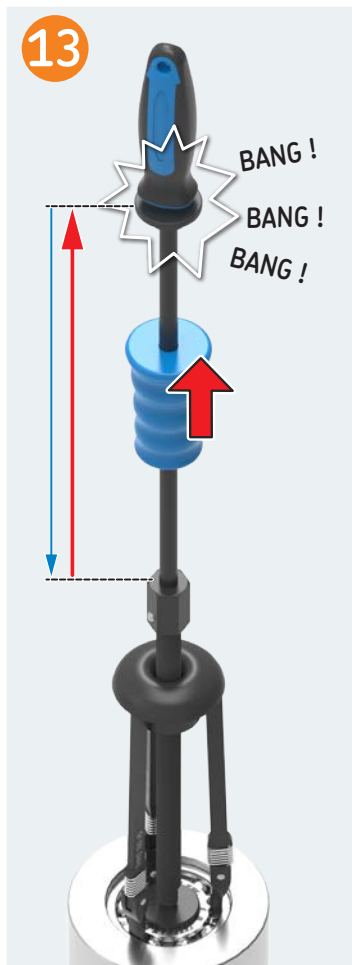
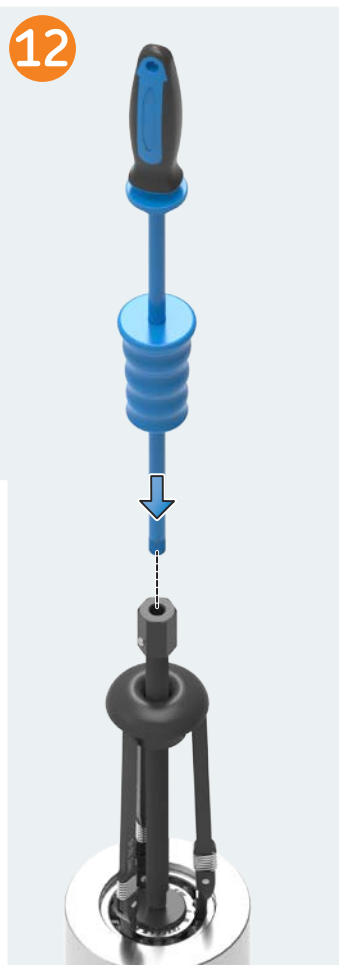
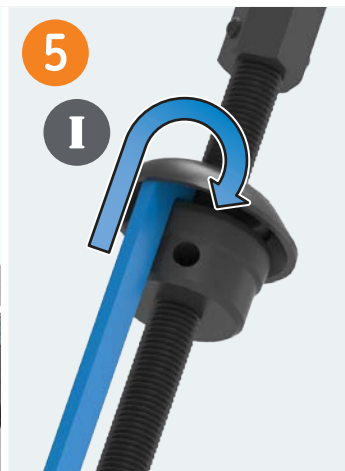

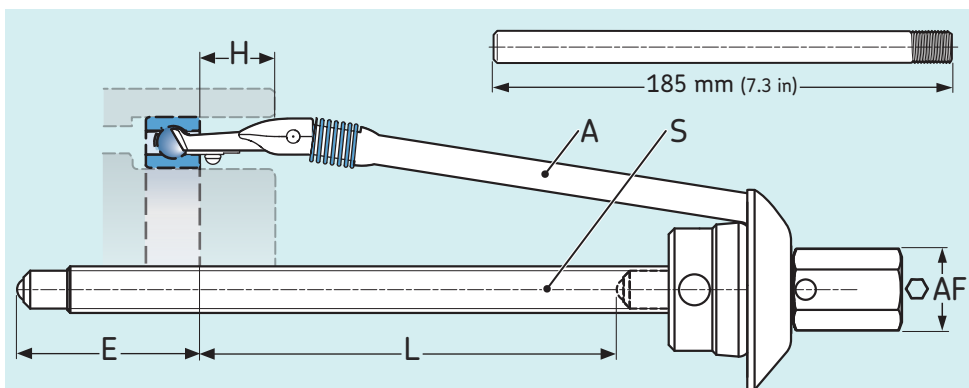

S	A	L		H		E		AF
		mm	in	mm	in	mm	in	
TMMD 100-S1	TMMD 100-A2	135	5.3	16	0.6	79	3.1	19 3/4"
	TMMD 100-A3	137	5.4	23	0.9	77	3.0	
TMMD 100-S2	TMMD 100-A4	162	6.4	26	1.0	52	2.0	24 15/16"
	TMMD 100-A5	167	6.6	52	2.0	49	1.9	
	TMMD 100-A6	170	6.7	100	3.9	49	1.9	

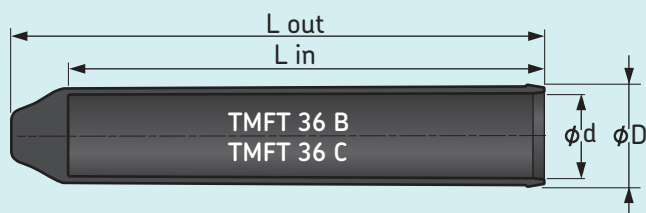

	d		D		L <sub>in</sub>		L <sub>out</sub>	
	mm	in	mm	in	mm	in	mm	in
TMFT 36 B	37	1.4	45	1.7	210	8.3	235	9.3
TMFT 36 C	57	2.2	66	2.6	215	8.4	245	9.6

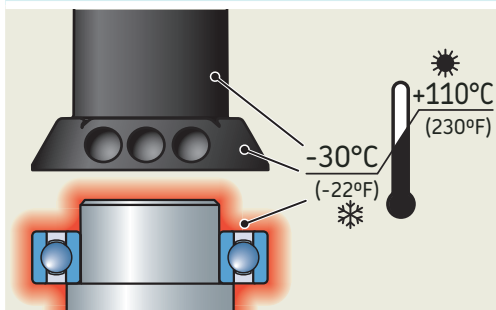
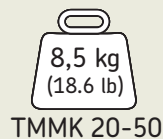

TDTC 1/C

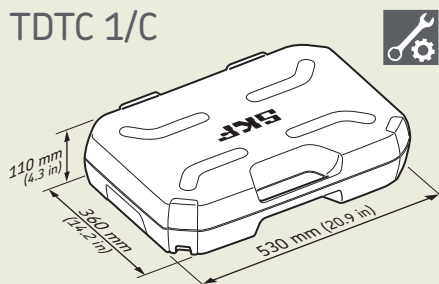

## TMMX 210

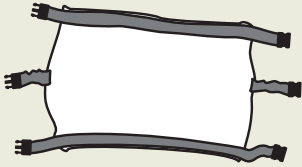

## LGEV 2/0.035

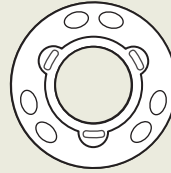

TMFT 36 B20-42 TMFT 36 B25-47  
 TMFT 36 B20-47 TMFT 36 B25-52  
 TMFT 36 B20-52 TMFT 36 B25-62  
 TMFT 36 B30-55 TMFT 36 B35-62  
 TMFT 36 B30-62 TMFT 36 B35-72  
 TMFT 36 B30-72 TMFT 36 B35-80

## TMFT 36-H

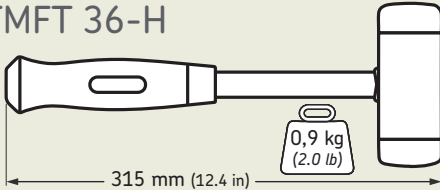

## TMMD 100-A2

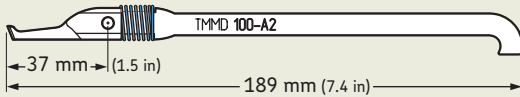

## TMMD 100-A3

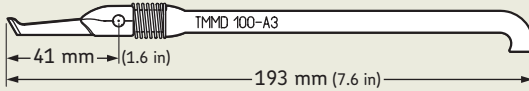

## TMMD 100-A4

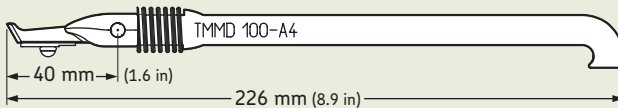

## TMMD 100-A5

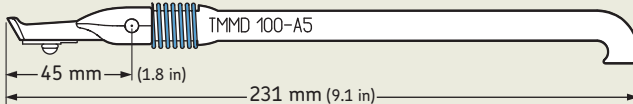

## TMMD 100-A6

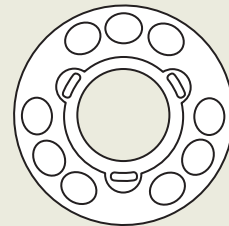
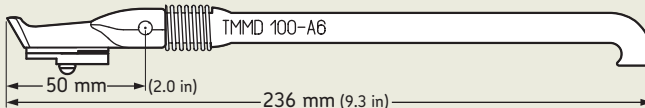

TMFT 36 C40-68 TMFT 36 C50-80  
 TMFT 36 C40-80 TMFT 36 C50-90  
 TMFT 36 C40-90 TMFT 36 C50-110  
 TMFT 36 C45-75  
 TMFT 36 C45-85  
 TMFT 36 C45-100

## TMIP S1

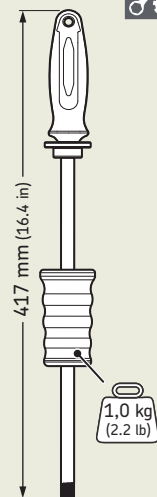

The contents of this publication are the copyright of the publisher and may not be reproduced (even extracts) unless prior written permission is granted. Every care has been taken to ensure the accuracy of the information contained in this publication but no liability can be accepted for any loss or damage whether direct, indirect or consequential arising out of the use of the information contained herein.

Le contenu de cette publication est soumis au copyright de l'éditeur et sa reproduction, même partielle, est interdite sans autorisation écrite préalable. Le plus grand soin a été apporté à l'exactitude des informations données dans cette publication mais SKF décline toute responsabilité pour les pertes ou dommages directs ou indirects découlant de l'utilisation du contenu du présent document.

Nachdruck, auch auszugsweise, nur mit unserer vorherigen schriftlichen Genehmigung gestattet. Die Angaben in dieser Druckschrift wurden mit größter Sorgfalt auf ihre Richtigkeit hin überprüft. Trotzdem kann keine Haftung für Verluste oder Schäden irgendwelcher Art übernommen werden, die sich mittelbar oder unmittelbar aus der Verwendung der hier enthaltenen Informationen ergeben.

El contenido de esta publicación es propiedad de los editores y no puede reproducirse (incluso parcialmente) sin autorización previa por escrito. Se ha tenido el máximo cuidado para garantizar la exactitud de la información contenida en esta publicación, pero no se acepta ninguna responsabilidad por pérdidas o daños, ya sean directos, indirectos o consecuentes, que se produzcan como resultado del uso de dicha información.

La riproduzione, anche parziale, del contenuto di questa pubblicazione è consentita soltanto previa autorizzazione scritta della SKF. Nella stesura è stata dedicata la massima attenzione al fine di assicurare l'accuratezza dei dati, tuttavia non si possono accettare responsabilità per eventuali errori od omissioni, nonché per danni o perdite diretti o indiretti derivanti dall'uso delle informazioni qui contenute.

O conteúdo desta publicação é de direito autoral do editor e não pode ser reproduzido (nem mesmo parcialmente), a não ser com permissão prévia por escrito. Todo cuidado foi tomado para assegurar a precisão das informações contidas nesta publicação, mas nenhuma responsabilidade pode ser aceita por qualquer perda ou dano, seja direto, indireto ou consequente como resultado do uso das informações aqui contidas.

本出版物内容的著作权归出版者所有且未经事先书面许可不得被复制（甚至引用）。我们已采取了一切注意措施以确定本出版物包含的信息准确无误，但我们不对因使用此等信息而产生的任何损失或损害承担任何责任，不论此等责任是直接、间接或附随性的。

Содержание этой публикации является собственностью издателя и не может быть воспроизведено (даже частично) без предварительного письменного разрешения. Несмотря на то, что были приняты все меры по обеспечению точности информации, содержащейся в настоящем издании, издатель не несет ответственности за любой ущерб, прямой или косвенный, вытекающий из использования вышеуказанной информации.



[skf.com](http://skf.com) | [mapro.skf.com](http://mapro.skf.com) | [skf.com/mount](http://skf.com/mount)

© SKF is a registered trademark of the SKF Group.

© SKF Group 2018

MP5444 · 2018/04