











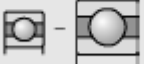
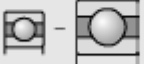
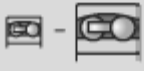
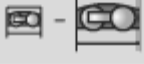
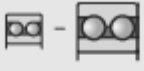
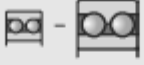
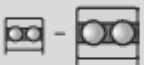
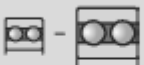

SKF Belső csapáglehúzó



				
	TMIP E7-9	TMIP E10-12	TMIP E15-17	TMIP E20-28
$d_{min} - d_{max}$ mm	7 - 9	10 - 12	15 - 17	20 - 28
in	0.28 - 0.35	0.39 - 0.47	0.59 - 0.67	0.79 - 1.1
 - 	607 - 629 618/7 - 619/9	6000 - 6301 16000 - 16101	6002 - 6403 16002 - 16003	6004 - 6405 16004 - 16005 62/22 - 63/28
 - 	127 - 129	1200 - 2301	1202 - 2303	1204 - 2305
 - 		3200 - 5201	3202 - 3303	3204 - 3305
 - 		4200 - 4301	4202 - 4303	4204 - 4305

1 ? ? ?

				
$d_{su} - d_{su}$ mm	7 - 9	10 - 12	15 - 17	20 - 28
in	0.28 - 0.35	0.39 - 0.47	0.59 - 0.67	0.79 - 1.1
	607 - 629 618/7 - 619/9	6000 - 6301 16000 - 16101	6002 - 6403 16002 - 16003	6004 - 6405 16004 - 16005 62/22 - 63/28
	127 - 129	1200 - 2301	1202 - 2303	1204 - 2305
		3200 - 5201	3202 - 3303	3204 - 3305
		4200 - 4301	4202 - 4303	4204 - 4305

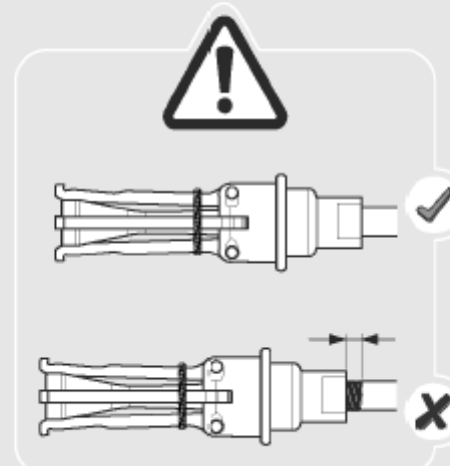
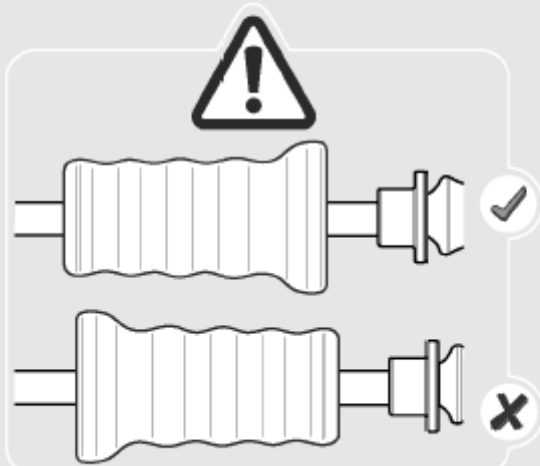
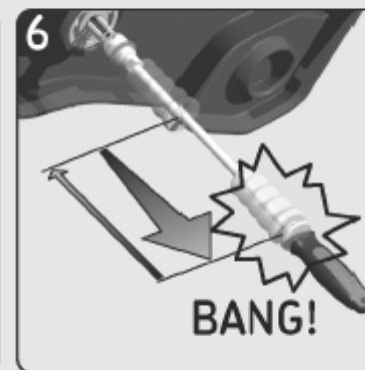
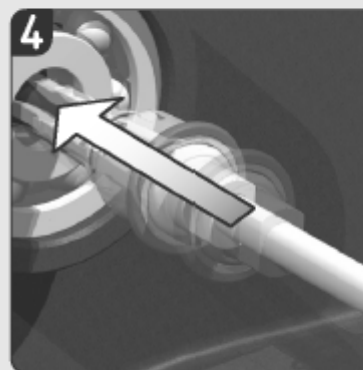
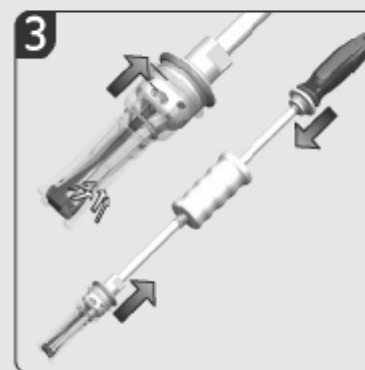
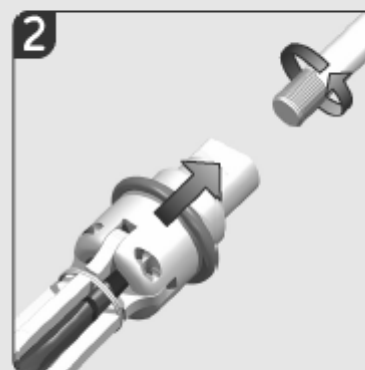

SKF TMIP 7-28

Használati útmutató

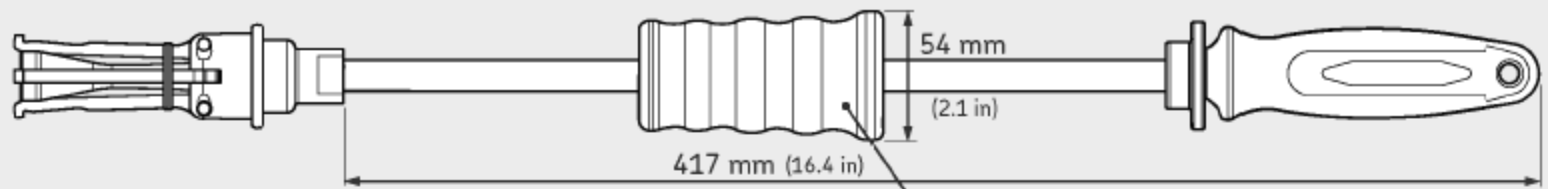

	A_{max}		L_{max}		H		G	
	mm	in	mm	in	mm	in	mm	in
TMIP E7-9	6	0.24	38	1.5	>8	>0.3	88	3.5
TMIP E10-12	6	0.24	41	1.6	>17	>0.7	88	3.5
TMIP E15-17	6.5	0.26	49	1.9	>22	>0.9	118	4.6
TMIP E20-28	10	0.4	60	2.4	>24	>0.95	127	5.0

