

# YET 207-107

## Dimensions

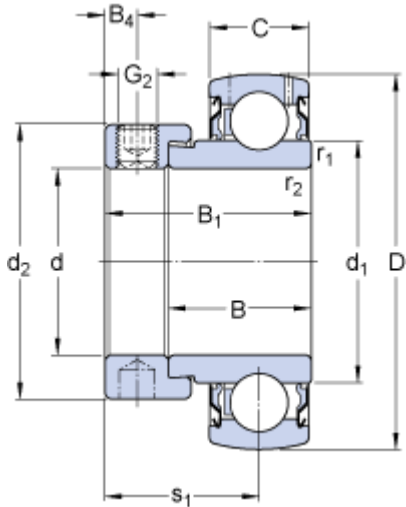

d	36.513	mm
D	72	mm
B <sub>1</sub>	38.9	mm
B	25.4	mm
C	19	mm
d <sub>1</sub>	≈ 46.1	mm
d <sub>2</sub>	51.1	mm
B <sub>4</sub>	6.75	mm
r <sub>1,2</sub>	min. 1	mm
s <sub>1</sub>	29.4	mm

## Calculation data

Basic dynamic load rating	C	25.5	kN
Basic static load rating	C	15.3	kN
Fatigue load limit	P <sub>u</sub>	0.655	kN
Limiting speed <sup>1)</sup>		5300	r/min
Calculation factor	f	14	

## Mass

Mass complete bearing		0.44	kg
-----------------------	--	------	----

## Mounting information

Thread grub screw	G <sub>2</sub>	3/8-24 UNF	
Hexagonal key size for grub screw	N	4.763	mm
Recommended tightening torque for grub screw		16.5	N·m

## Associated products

Rubber seating ring		<a href="#">RIS 207 A</a>	
---------------------	--	---------------------------	--