

YAR 210-2F

Dimensions

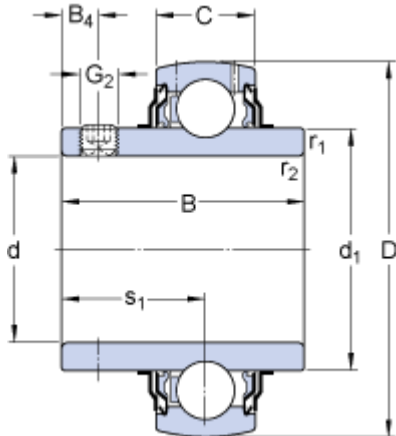

d	50	mm
D	90	mm
B	51.6	mm
C	22	mm
d ₁	≈ 62.51	mm
B ₄	9	mm
r _{1,2}	min. 1	mm
s ₁	32.6	mm

Calculation data

Basic dynamic load rating	C	35.1	kN
Basic static load rating	C	23.2	kN
Fatigue load limit	P _u	0.98	kN
Limiting speed ¹⁾		4000	r/min
Calculation factor	f	14	

Mass

Mass complete bearing		0.76	kg
-----------------------	--	------	----

Mounting information

Thread grub screw	G ₂	M10x1	
Hexagonal key size for grub screw	N	5	mm
Recommended tightening torque for grub screw		16.5	N·m