

YAR 207-107-2F

Dimensions

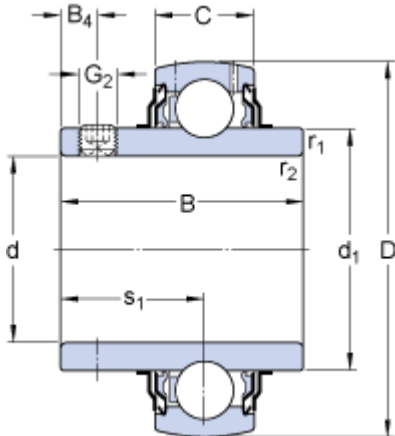

d		36.513	mm
D		72	mm
B		42.9	mm
C		19	mm
d ₁	≈	46.1	mm
B ₄		6	mm
r _{1,2}	min.	1	mm
s ₁		25.4	mm

Calculation data

Basic dynamic load rating	C	25.5	kN
Basic static load rating	C	15.3	kN
Fatigue load limit	P _u	0.655	kN
Limiting speed ¹⁾		5300	r/min
Calculation factor	f	14	

Mass

Mass complete bearing		0.42	kg
-----------------------	--	------	----

Mounting information

Thread grub screw	G ₂	5/16-24 UNF	
Hexagonal key size for grub screw	N	3.969	mm
Recommended tightening torque for grub screw		6.5	N·m

Associated products

Rubber seating ring		RIS 207 A	
---------------------	--	---------------------------	--