

YAR 206-104-2F

Dimensions

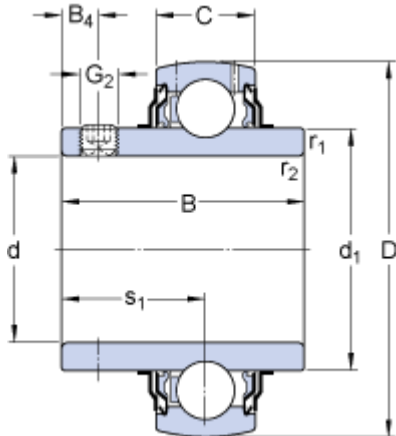

d		31.75	mm
D		62	mm
B		38.1	mm
C		18	mm
d ₁	≈	39.7	mm
B ₄		5	mm
r _{1,2}	min.	0.6	mm
s ₁		22.2	mm

Calculation data

Basic dynamic load rating	C	19.5	kN
Basic static load rating	C	11.2	kN
Fatigue load limit	P _u	0.475	kN
Limiting speed ¹⁾		6300	r/min
Calculation factor	f	14	

Mass

Mass complete bearing		0.28	kg
-----------------------	--	------	----

Mounting information

Thread grub screw	G ₂	1/4-28 UNF	
Hexagonal key size for grub screw	N	3.175	mm
Recommended tightening torque for grub screw		4	N·m

Associated products

Rubber seating ring		RIS 206 A	
---------------------	--	---------------------------	--