

# W 6002-2RS1

## Dimensions

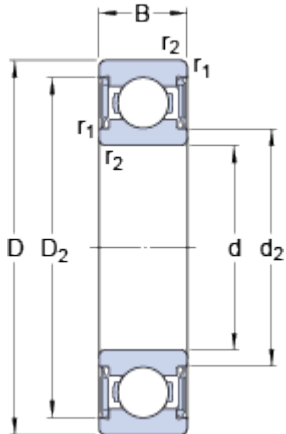

d	15	mm
D	32	mm
B	9	mm
d <sub>2</sub>	≈ 18.6	mm
D <sub>2</sub>	≈ 29.05	mm
r <sub>1,2</sub>	min. 0.3	mm

## Abutment dimensions

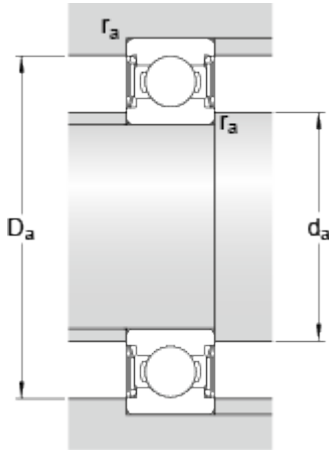

d <sub>a</sub>	min.	17	mm
d <sub>a</sub>	max.	18.5	mm
D <sub>a</sub>	max.	30	mm
r <sub>a</sub>	max.	0.3	mm

## Calculation data

Basic dynamic load rating	C	4.88	kN
Basic static load rating	C	2.8	kN
Fatigue load limit	P <sub>u</sub>	0.12	kN
Limiting speed		14000	r/min
Calculation factor	k <sub>r</sub>	0.03	
Calculation factor	f	13.9	

## Mass

Mass bearing		0.028	kg
--------------	--	-------	----