

SYF 507

Dimensions

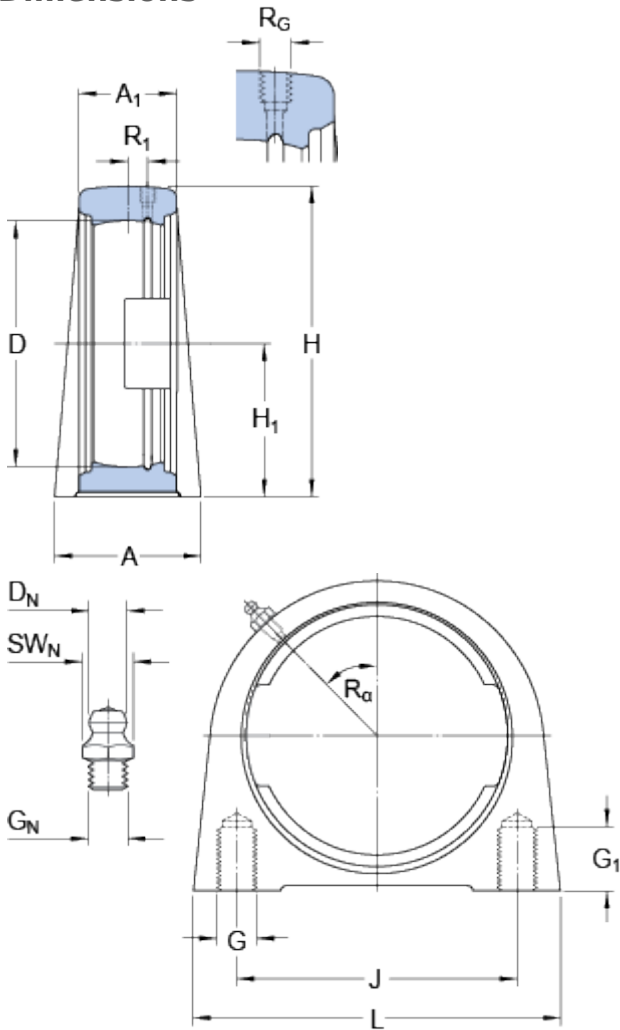

D	72	mm
H_1	47.6	mm
A	45	mm
A_1	27	mm
H	93	mm
J	82.6	mm
L	103	mm

Threaded hole

R_G	1/4-28 UNF
R_1	3 mm
R_a	45 °

Grease fitting

D_N	6.5	mm
SW_N	7	mm
G_N	1/4-28 SAE-LT	

Mass

Mass housing	0.85	kg
--------------	------	----

Mounting information

Housing thread for attachment bolts	G	M10
Thread length	G_1	15 mm