

# SA 8 E

## Dimensions

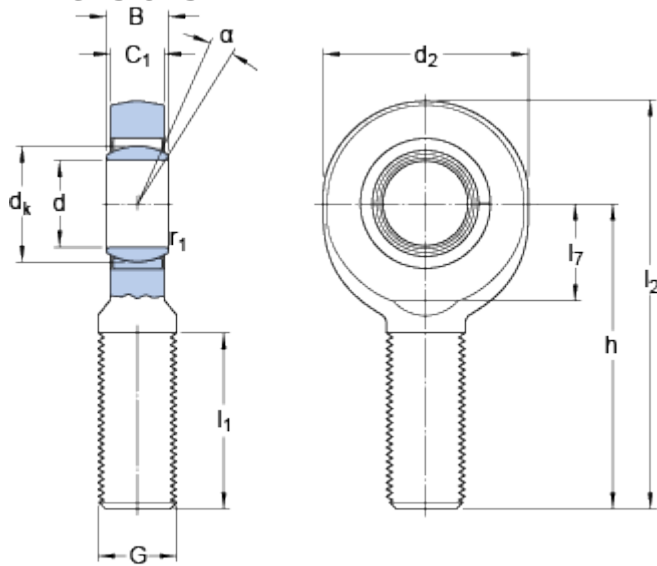

d		8	mm
d <sub>2</sub>	max.	25	mm
B		8	mm
G		M 8	
C <sub>1</sub>	max.	6.5	mm
h		42	mm
α		15	°
d <sub>k</sub>		13	mm
l <sub>1</sub>	min.	21	mm
l <sub>2</sub>	max.	56	mm
l <sub>7</sub>	min.	11	mm
r <sub>1</sub>	min.	0.3	mm

## Calculation data

Basic dynamic load rating	C	5.5	kN
Basic static load rating	C	12.9	kN
Specific dynamic load factor	K	100	N/mm <sup>2</sup>
Material constant	K <sub>M</sub>	330	

## Mass

Mass rod end	0.029	kg
--------------	-------	----