

SALKAC 5 M

Dimensions

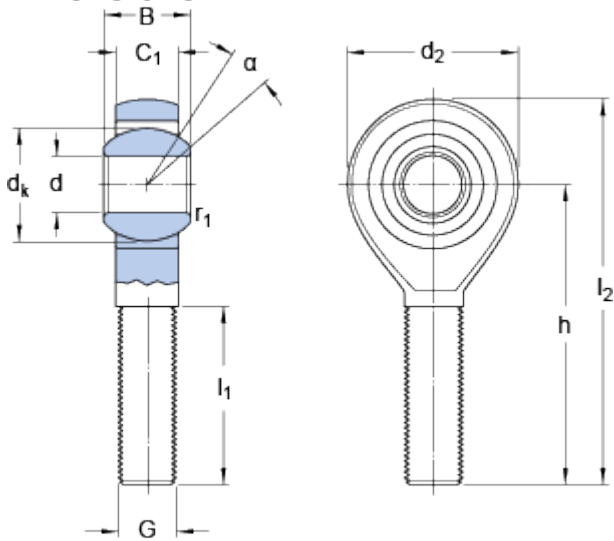

d		5	mm
d ₂	max.	19	mm
B		8	mm
G		M 5	
C ₁	max.	7.5	mm
h		33	mm
α		13	°
d _k		11.1	mm
l ₁	min.	19	mm
l ₂	max.	44	mm
r ₁	min.	0.3	mm

Calculation data

Basic dynamic load rating	C	3.25	kN
Basic static load rating	C	4.8	kN
Specific dynamic load factor	K	50	N/mm ²
Material constant	K _M	330	

Mass

Mass rod end	0.013	kg
--------------	-------	----