

# PHS 60-1B64

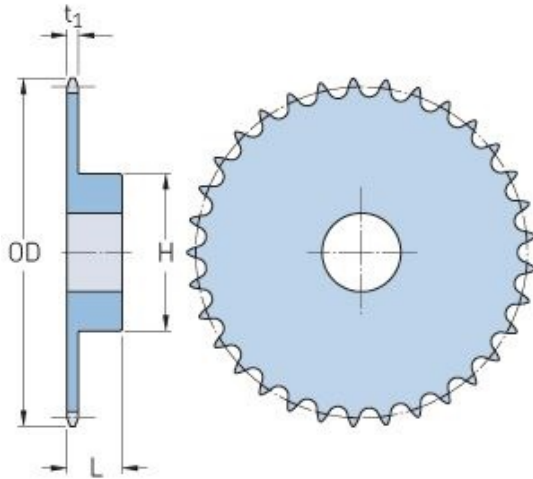

Pitch P (in)	0.75
No. of teeth	64
Diameter (in)	15.72
Min. bore (in)	1.25
Max. bore (in)	2.75
Hub H (in)	4.25
Hub L (in)	1.75
Weight (lbs)	27.4