

PHS 60-1B58

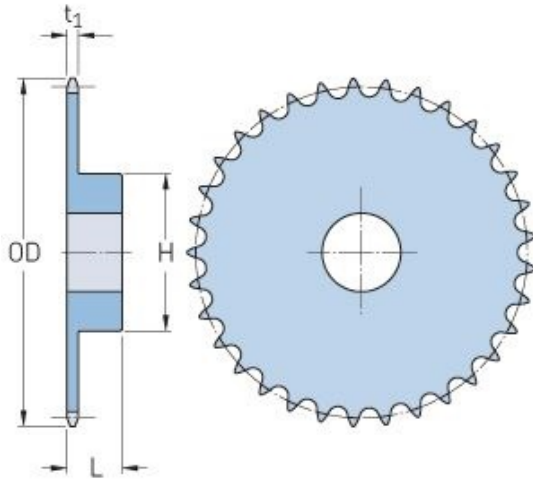

Pitch P (in)	0.75
No. of teeth	58
Diameter (in)	14.28
Min. bore (in)	1.25
Max. bore (in)	2.75
Hub H (in)	4.25
Hub L (in)	1.75
Weight (lbs)	22.8