

# PHS 60-1B54

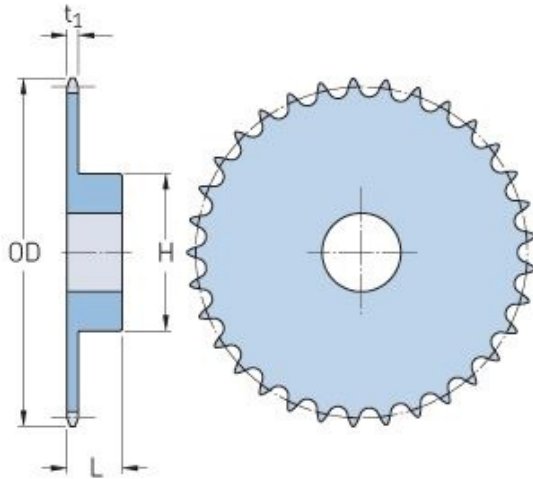

Pitch P (in)	0.75
No. of teeth	54
Diameter (in)	13.33
Min. bore (in)	0.94
Max. bore (in)	2.75
Hub H (in)	4.25
Hub L (in)	1.75
Weight (lbs)	21.6