

PHS 60-1B49

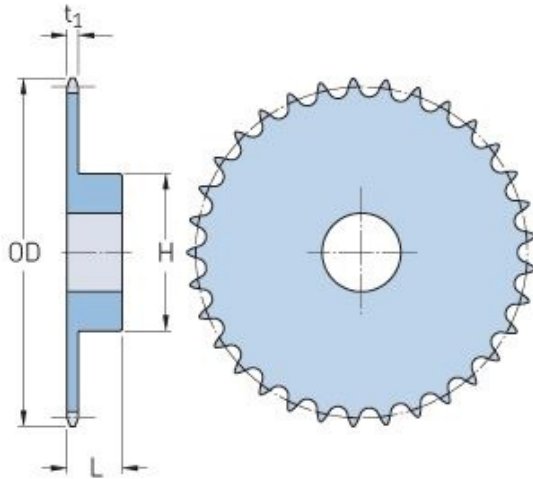

Pitch P (in)	0.75
No. of teeth	49
Diameter (in)	12.13
Min. bore (in)	0.94
Max. bore (in)	2.75
Hub H (in)	4.25
Hub L (in)	1.25
Weight (lbs)	15.9