

# PHS 60-1B26

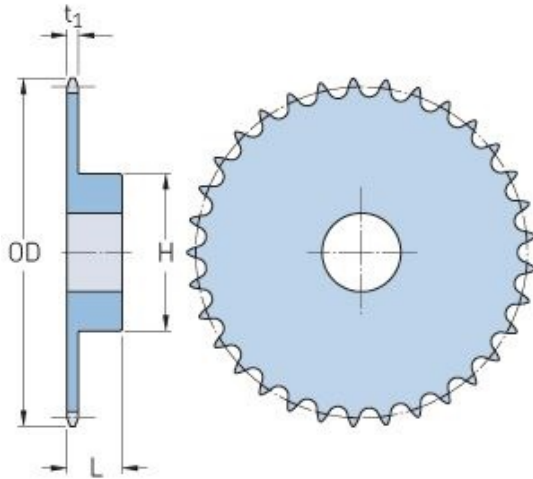

Pitch P (in)	0.75
No. of teeth	26
Diameter (in)	6.63
Min. bore (in)	0.75
Max. bore (in)	2.75
Hub H (in)	4
Hub L (in)	1.25
Weight (lbs)	6.38