

PHS 50-1B46

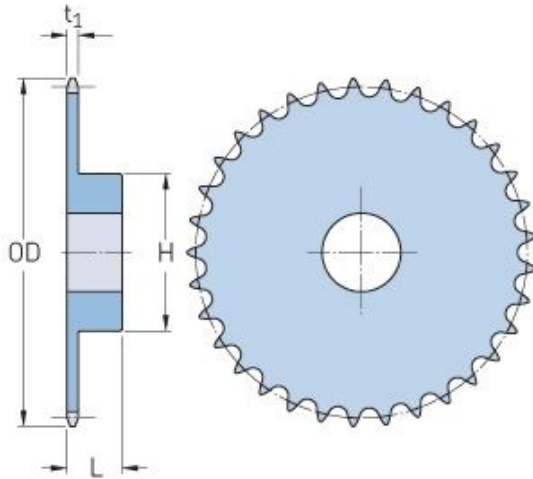

Pitch P (in)	0.63
No. of teeth	46
Diameter (in)	9.51
Min. bore (in)	1
Max. bore (in)	2.5
Hub H (in)	3.75
Hub L (in)	1.25
Weight (lbs)	8.22