

PHS 41-1B60

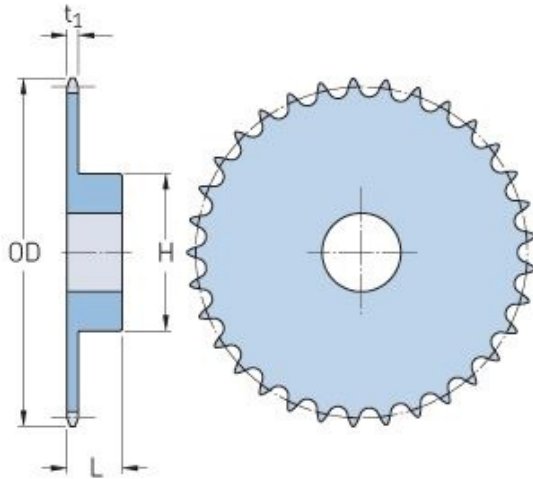

Pitch P (in)	0.5
No. of teeth	60
Diameter (in)	9.84
Min. bore (in)	0.75
Max. bore (in)	2.38
Hub H (in)	3.5
Hub L (in)	1.06
Weight (lbs)	6.78