

PHS 40-1B72

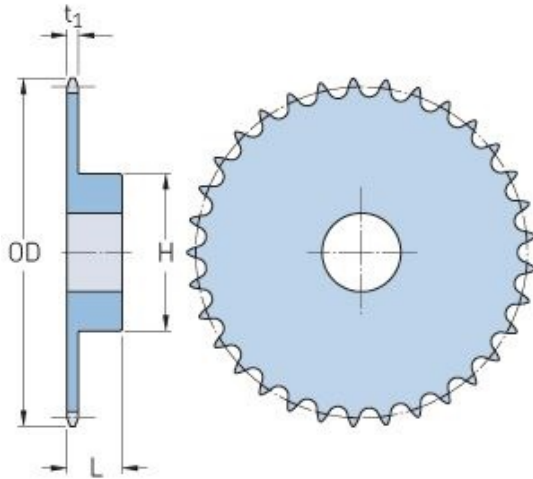

Pitch P (in)	0.5
No. of teeth	72
Diameter (in)	11.75
Min. bore (in)	0.75
Max. bore (in)	2.75
Hub H (in)	4
Hub L (in)	1.25
Weight (lbs)	11.5