

# PHS 35-1B35

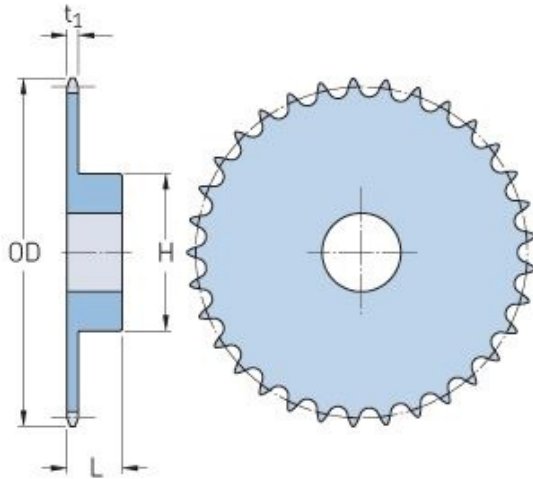

Pitch P (in)	0.38
No. of teeth	35
Diameter (in)	4.39
Min. bore (in)	0.63
Max. bore (in)	1.5
Hub H (in)	2.25
Hub L (in)	0.88
Weight (lbs)	1.5