

PHS 35-1B30

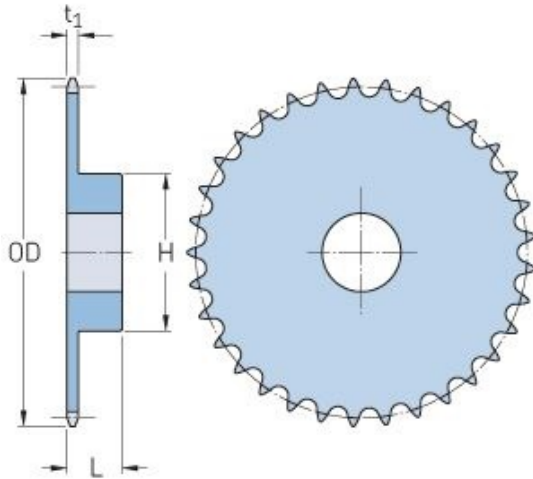

Pitch P (in)	0.38
No. of teeth	30
Diameter (in)	3.79
Min. bore (in)	0.5
Max. bore (in)	1.38
Hub H (in)	2
Hub L (in)	0.88
Weight (lbs)	1.02