

PHS 25-1B14

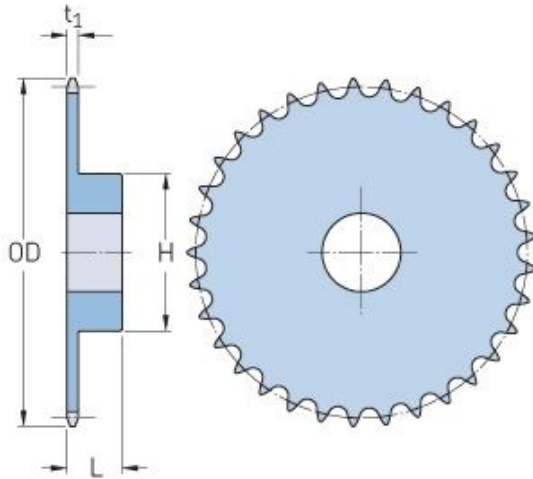

Pitch P (in)	0.25
No. of teeth	14
Diameter (in)	1.25
Min. bore (in)	0.25
Max. bore (in)	0.56
Hub H (in)	1.19
Hub L (in)	0.5
Weight (lbs)	0.08