

# PHS 12B-1A20

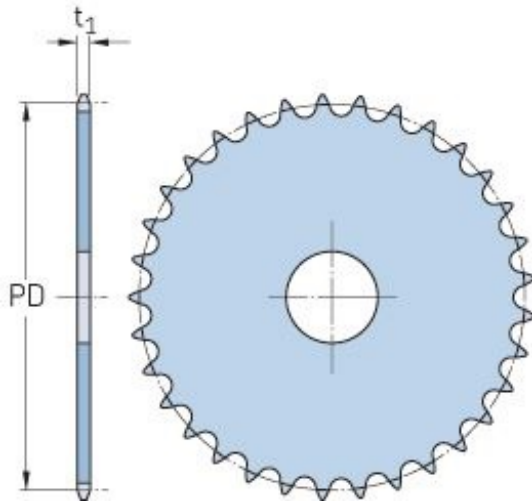

Pitch P (mm)	19.05
Pitch P (in)	0.75
No. of teeth	20
Pitch diameter (mm)	121.78
Pitch diameter (in)	4.79
Min. bore (mm)	-
Min. bore (in)	-
Max. bore (mm)	-
Max. bore (in)	-
Hub H (mm)	-
Hub H (in)	-
Hub L (mm)	-
Hub L (in)	-
Weight (kg)	0.9
Weight (lbs)	1.98