

PHE 1110TGHCOVER

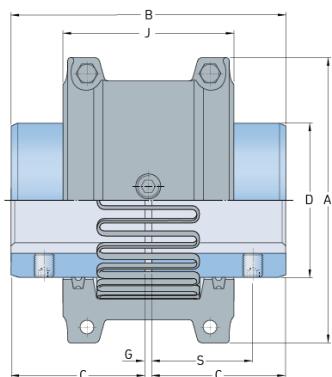

Size	1110
Nominal torque (lbft)	6874.08
Nominal torque (Nm)	9320
Min. bore (mm)	41
Max speed (r/min)	2250
Min. bore (in)	1.61
Max. bore (mm)	117
Max. bore (in)	4.61
Weight (kg)	5.4
Weight (lbs)	11.9