

# PHC 80-1C/L

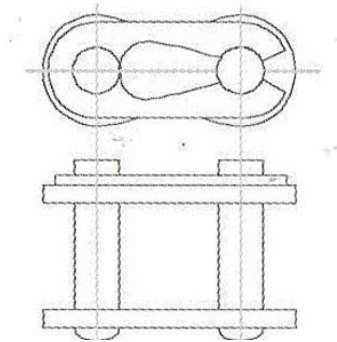

Type of link	C/L
--------------	-----