

# PHC 60-2C/L

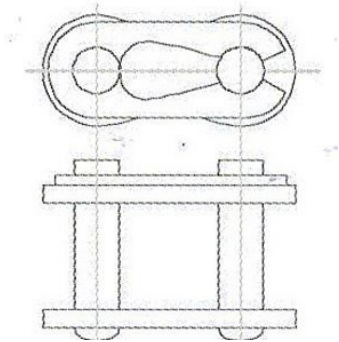

|              |     |
|--------------|-----|
| Type of link | C/L |
|--------------|-----|