

PHC 12B-2SLRX10FT

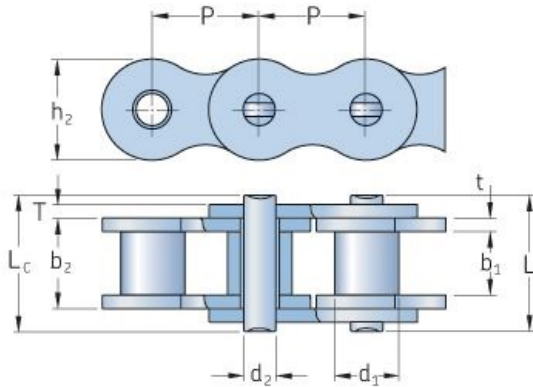

Pitch P (mm)	19.05
Pitch P (in)	0.75
Roller diameter d1 max (mm)	12.07
Roller diameter d1 max (in)	0.48
Width between inner plates b1 max (mm)	11.68
Width between inner plates b1 max (in)	0.46
Pin diameter d2 max (mm)	5.72
Pin diameter d2 max (in)	0.23
Plate height h2 max (mm)	16
Plate height h2 max (in)	0.63
Plate thickness T max (mm)	1.85
Plate thickness T max (in)	0.07
Weight (kg/m)	2.31
Weight (lbs/ft)	-

© SKF is a registered trademark of the SKF Group
© SKF Group 2012

The contents of this publication are the copyright of the publisher and may not be reproduced (even extracts) unless prior written permission is granted. Every care has been taken to ensure the accuracy of the information contained in this publication but no liability can be accepted for any loss or damage whether direct, indirect or consequential arising out of the use of the information contained herein.